

Report for GSMA on the Coexistence of ISDB-T and LTE

W1306L4205

Proposal Author: Paul Grant

Appointment: Access Networks Lead Engineer

Approved: Nick Kirkman

Appointment: Technical Director

Issue Date 29th November 2013

Advanced Topographic Development & Images Limited
The Beehive
City Place
Gatwick Airport
RH6 0PA

Tel: +44 (0)1293 522052

CONTENTS

1	Executive summary	5
2	Introduction.....	10
	Modelling approach	10
	Purpose.....	10
3	Background	12
	Brazil and ISDB-T.....	12
	APT band plan	12
	Refarming the UHF broadcast band.....	13
4	Objective and Scope.....	15
5	Assumptions	18
6	Method Overview.....	20
6.1	Capture ISDB-T Transmitter Network Data	21
6.2	Calculate ISDB-T Coverage	21
6.3	Calculate Service Areas	22
6.4	Process LTE BS Data.....	23
6.5	Calculate LTE Station Coverage	23
6.6	Calculate Adjacent Channel Interference	24
6.7	Calculate Blocking Interference	27
6.8	Analogue Interference assessment.	29
6.8.1	LTE interferes with Analogue TV	29
6.8.1.1	Method for assessment of interference	29
6.8.1.2	Protection criteria.....	30
6.8.2	Analogue TV interferes with LTE	33
6.8.2.1	Method for assessment of interference	34
6.9	Investigate Mitigation Options.....	35
7	Results.....	36
7.1	LTE interference with ISDB-T	36
7.1.1	LTE BS interference with ISDB-T.....	36
7.1.1.1	Out of band interference	36
7.1.1.2	Blocking	47
7.1.2	LTE UE into ISDB-T.....	48
7.1.2.1	Out of band.....	48
7.1.2.2	Blocking	49

7.2	ISDB-T interference into LTE.....	50
7.2.1	ISDB-T into LTE BS	50
7.2.1.1	Out of band	50
7.2.1.2	Blocking	51
7.2.2	ISDB-T into LTE UE	52
7.2.2.1	Out of band	52
7.2.2.2	Blocking	53
7.3	Analogue TV Interference.....	54
7.3.1	LTE interference with analogue TV	54
7.3.2	Analogue TV interference with LTE	55
7.4	Results summary	58
8	Mitigation	60
8.1	Limit emission power in top broadcast channels	60
8.2	Filtering at the LTE base station	61
8.3	Reduce out of band LTE base station power spectra	64
8.4	Ad-Hoc filters at domestic ISDB-T receivers to reduce blocking interference from LTE.....	66
8.5	Specify improved antenna at the domestic receiver	66
8.6	Use of orthogonal polarisation for LTE BS.....	67
8.7	Specify the Use of Good Quality TV Receivers	68
9	Conclusions and recommendations.....	69
	Appendix A.....	71
	Appendix B.....	73
	Appendix C – 95% locations results.....	75
	LTE BS interference with ISDB-T (Out of band interference).....	75

Document history

Version	Issue date	Comments
Draft a	31-Oct-2013	Initial draft
Draft b	5-Nov-2013	Updated following internal review
Draft c	25-Nov 2013	Updated following review comments
Issue 1.0	29-Nov 2013	First Issue

1 EXECUTIVE SUMMARY

This study used modelling to examine the coexistence of the TV broadcast and planned LTE services following a digital dividend in Brazil when all analogue TV emissions cease and an equivalent service is provided by digital TV. The planned refarmed spectrum is shown below.

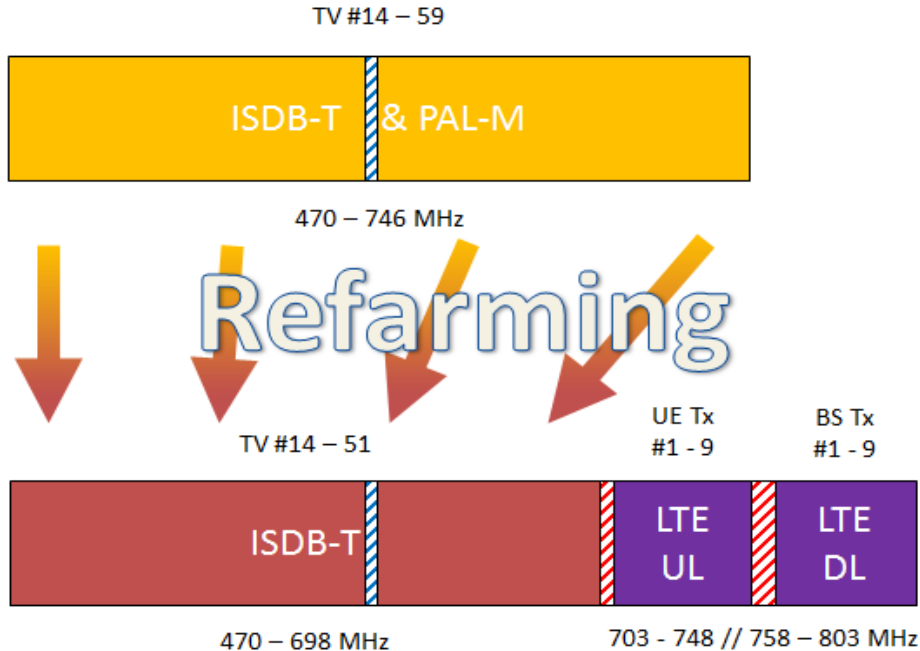

Analogue TV has also been considered as there will be a staggered switch off and so there will still be analogue services broadcasting at the same time as new mobile services.

The modelling scenarios considered are listed below

- LTE base station (BS) interferes with ISDB-T fixed rooftop receivers
- LTE user equipment (UE) interferes with ISDB-T fixed rooftop receivers
- ISDB-T interferes with LTE UE
- ISDB-T interferes with LTE BS
- LTE BS interfering with analogue TV
- LTE UE interfering with analogue TV
- Analogue TV interferes with LTE BS
- Analogue TV interferes with LTE UE

Method

The study undertook several types of modelling. The first scenario above used a planning tool with geo-spatial data to model the interference and the population affected. Three sample areas were considered, Sao Paulo, Brasilia and Campinas. In each area the LTE network was modelled using a representative network based on current mobile base station locations combined with typical emissive characteristics of an LTE network. For the ISDB-T network a representative network based on the existing and future stations following the implementation of the post dividend plan was used for the modelling. The remaining scenarios used the minimum coupling loss¹ approach to determine the minimum separation that would be required for each scenario so as not to suffer interference.

For each scenario the analysis considered two interference mechanisms:

- Out of band interference - this occurs when the unwanted signals, from an adjacent channel to the receiver, are captured by the receiver causing interference with the receiver, so preventing it from decoding the wanted signal without degradation.

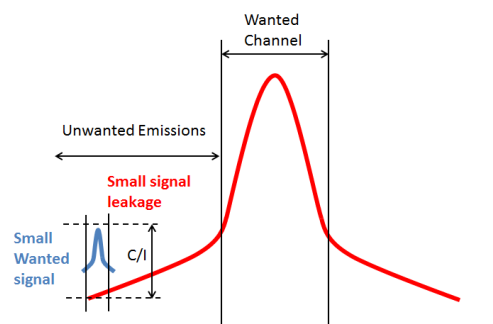

- Blocking interference - is where a strong unwanted signal prevents the receiver from detecting a wanted signal by driving it into overload. This interference can occur irrespective of the received signal level. The effect is not as frequency selective as out of band interference and can occur when the unwanted signal is many channels away.

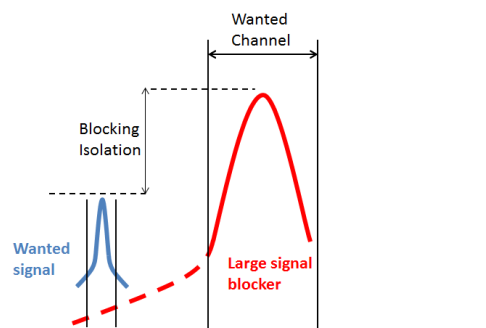

¹ ERC report 101

Results

The following tables give a summary of the results for each of the different scenarios. The probability of interference has been categorised into either: high, medium or low. Also shown is the probability of interference after mitigation is applied, where applicable. Mitigation options considered and those suggested for implementation are listed in the mitigation section.

LTE into ISDB-T

	Probability of interference			
	Out of band emissions (modelling tool approach)		Blocking (modelling tool approach)	
	Before mitigation	After mitigation	Before mitigation	After mitigation
LTE BS (30m antenna) into ISDB-T (10m fixed rooftop antenna)	Medium	Low	Low	-
LTE UE (1.5m) into ISDB-T (10m fixed rooftop antenna)	Low	-	Low	-

The population interfered (LTE BS into ISDB-T) is relatively low with typically less than 50,000 for Sao Paulo and less than 10,000 for Brasilia and Campinas for out of band interference. With mitigation applied those numbers could be virtually eliminated.

ISDB-T into LTE

	Probability of interference			
	Out of band emissions (MCL approach)		Blocking (MCL approach)	
	Before mitigation	After mitigation	before mitigation	After mitigation
ISDB-T (150m antenna) into LTE BS (30m antenna)	High	Low	High	Low
ISDB-T (150m antenna) into LTE UE (1.5m antenna)	Low	-	Low	-

For ISDB-T into LTE BS the separation distances required can be reduced from more than 10km to less than 600m following mitigation.

LTE into Analogue TV

	Probability of interference	
	Out of band emissions (MCL approach)	
	Before mitigation	After mitigation
LTE BS (30m antenna) into ATV (10 fixed rooftop antenna)	Medium	Low
LTE UE (1.5m antenna) into ATV (10m fixed rooftop antenna)	Low	-

For LTE base station into analogue TV the separation distance required is typically a few kilometres. For the uplink the separation distance required is generally less than 100m.

Analogue TV into LTE

	Probability of interference	
	Out of band emissions (MCL approach)	
	Before mitigation	After mitigation
ATV (150m antenna) into LTE BS (30m antenna)	High	Medium
ATV (150m antenna) into LTE UE (1.5m antenna)	Medium	-

For analogue TV into LTE base station the separation distance required is greater than 10km but reduces to below 10km with mitigation. For the LTE mobile the separation distance required is of the order of 10km.

Mitigation

A number of mitigation techniques were considered to explore the alleviation of potential interference issues, and these are listed below.

- Limit emission power in top TV broadcast channels
- LTE BS emission and receiver filtering
- Broadcast emission filtering
- Use of orthogonal polarisation
- Domestic TV receiver filtering
- Improved domestic antenna
- Good quality TV receivers

Of these options applying emission and receiver filters to the LTE base station and emission filters to the ISDB-T transmitter combined with limiting the emission power in the top TV broadcast channels are the most beneficial. Applying emission and reception filters is however likely to be the most costly option but does reduce the probability of interference.

The probability of interference from Analogue TV into LTE is classed as medium. Filtering on the analogue transmitters, which would reduce the out of band emissions and was not modelled as the analogue transmitters are scheduled for switch off within the next few years, and it is not believed to be cost effective to implement. A combination of frequency and geographic separation would be required to find an acceptable solution during the transition period from analogue to digital.

The options for the domestic TV receiver, for example apply a blocking filter, should be used on a case by case basis where local interference issues are experienced.

Conclusions and Recommendations

As a general rule, the cell edge of the wanted service areas are the most vulnerable to out of band interference and blocking is generally confined to areas in close proximity to the transmitters. The levels of predicted interference are generally low in most of the scenarios considered and by applying suitable mitigation the worst cases can be reduced to acceptable levels.

The following recommendations should be considered:

- Apply an emission filter to the ISDB-T transmitter to achieve, and ideally exceed the critical transmission mask.
- Apply an emission filter to the LTE base station to reduce out of band interference
- Apply a receiver filter to the LTE base station to reduce blocking interference.
- Adopt post dividend plans that avoid high power emissions in the upper TV channels (especially channels 48-51).
- Have a frequency separation of at least 20MHz between the analogue TV and the LTE receivers to help reduce the separation distances required to an acceptable level during the analogue to digital transition period.
- Apply mitigation at the domestic TV receiver on a case by case basis to overcome any local interference issues.

The general conclusion is provided suitable mitigations are applied that coexistence between LTE and ISDB-T is possible.

2 INTRODUCTION

The GSMA are supporting their members in Brazil during the national planning process to re-farm the 700MHz band for mobile services. As part of this, guidance as to how cellular and broadcast operators systems can coexist is essential. The GSMA have contracted ATDI to act as independent consultants to examine the potential interference between the two systems and look at how successful coexistence may be achieved.

The study explores the issues with the cellular and broadcast services operating in close proximity to one another however, it is not designed to prescribe a specific solution. But, through the use of modelling, the study will provide an objective viewpoint from which to base any decisions.

Measurement data exists for ISDB-T and IMT systems and this is useful for establishing coexistence rules. However, it is useful to determine the impact of interference which is what this report endeavours to do. This is achieved by modelling the likely interference situation for sample areas and equating this in terms of a denial of service to a population. The modelling will give an additional dimension that measurement cannot readily provide.

Modelling approach

The modelling uses a planning approach with planning figures based on ITU and Anatel sources to provide results that are meaningful and useful. This modelling approach has been successfully used on many similar coexistence situations to explore the issues and to inform the debate and decision process.

The modelling uses a number of scenarios to explore the potential interference between the broadcast and cellular services. Three study areas are used and these are Sao Paulo, Brasilia and Campinas. They were chosen as these are likely to be some of the most constrained areas due to the number of television stations, and the likelihood of a dense urban cellular network, and the potential problems should be less acute in other areas and therefore easier to mitigate.

Purpose

The purpose of this document is to present the results of modelling the compatibility of LTE adjacent to ISDB-T following a digital dividend in Brazil where all analogue TV emissions cease and an equivalent service is provided by digital TV. The modelling will examine the case for the coexistence of LTE and ISDB-T, exploring simple mitigations where necessary.

Compatibility with analogue TV is also included as GSMA have identified that there will be a long transition, over the next five years, from analogue to digital. So some regions may still have analogue services, whilst adjacent regions may have already migrated and implemented LTE mobile. There is therefore a requirement to understand the coexistence of LTE with analogue TV.

The next sections detail the scope of the study and its methodology before presenting the results of the modelling and conclusions arising.

3 BACKGROUND

Terrestrial TV broadcasting is very important in Brazil with the current analogue services covering large geographic areas, much of which has a low population density. Free to air TV services are by far the most popular with penetration rates of pay-tv low although on the increase.

Analogue TV is implemented in Brazil using the PAL-M variant, which is a 525 scan line system interlaced at 60 Hz with colour encoded with the PAL system contained in a 6 MHz channel. The majority of analogue transmissions by the main TV networks are in the VHF band.

Brazil and ISDB-T

In 2006 Brazil adopted a variant of the Japanese ISDB-T standard to use for its terrestrial digital TV network. Digital TV has since used both VHF and UHF bands with the digital and analogue services broadcasting simultaneously. The implementation of the digital switchover plan will gradually see the analogue services switched off with digital transmissions migrated to below 700MHz. This will therefore free up spectrum in the 700MHz band that is intended for mobile broadband use (E-UTRA operating band 28). This releasing of spectrum from the broadcast TV band is commonly referred to as the digital dividend. The IMT technology that is commonly proposed is LTE, and this will be the case in Brazil and so it will be used in this study.

The 1st digital dividend has already taken place in a number of European countries with the spectrum released being utilised typically for mobile broadband services due to the favourable propagation characteristics in the 800MHz bands, and a second dividend is being considered at 700MHz. The dividend in 700MHz is intended for many of the Latin American countries including Brazil where mobile broadband carries arguably even greater importance than in Europe, due to the lack of availability of fixed line broadband services.

APT band plan

The band plan that has been adopted by most of the Latin American countries is the APT (Asia-Pacific Telecommunity) 700MHz band plan. Brazil has also adopted the APT band plan and the harmonised FDD arrangement for this band is shown in Figure 1.

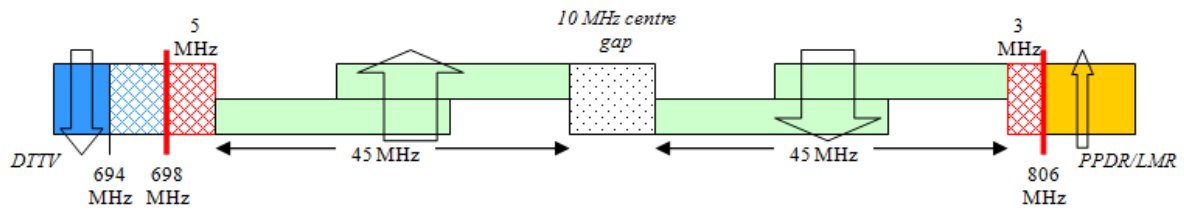

Figure 1: APT 700MHz band plan² (Harmonised FDD arrangement)

Reforming the UHF broadcast band

In the near future analogue TV emissions in Brazil will cease and only digital TV will exist up to channel 51 following the reforming of the spectrum.

According to the ANATEL public consultation 12 of 27 February 2013, the frequency arrangement for the UHF broadcast band will eventually become as shown in the figure below.

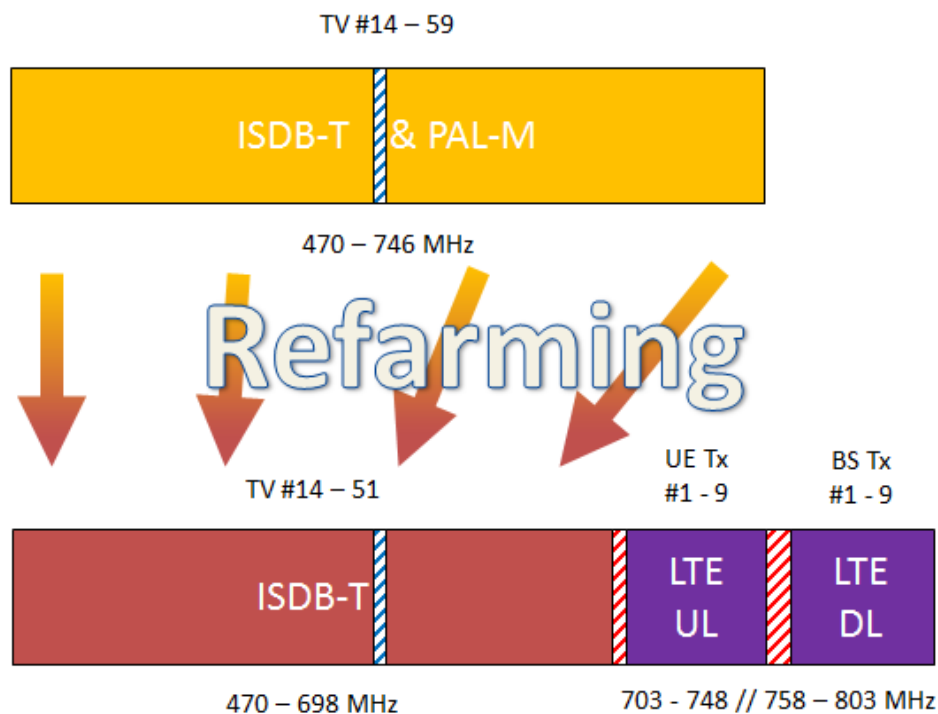

Figure 2: Reforming the UHF broadcast band

² APT report on Harmonised Frequency Arrangements for the Band 698-806MHz (no. APT/AWF/REP-14, Edition: September 2010)

Brazil is currently undertaking re-planning with a view to implementing this refarming activity. The analogue switch off was scheduled to be completed by 2016 but it is now envisaged that there will be analogue services transmitting until 2018 and this will be considered as part of this study.

Other interference studies and measurements have been completed in ITU region 1 where analogue television switch-off has already been completed in several European countries. The television standard of choice in region 1 is DVB-T as opposed to ISDB-T in Brazil (ITU region 2). But, recent contributions to the ITU, notably document 146E, have suggested that protection and overload thresholds for ISDB-T are similar to DVB-T and the results of sharing and compatibility studies for DVB-T can also be applied to ISDB-T. However, this study will use data specific to ISDB-T systems where possible.

4 OBJECTIVE AND SCOPE

The objective of this study is to quantify how much interference prospective LTE stations may contribute into the ISDB-T broadcasting service in terms of coverage loss for domestic receivers using a directive rooftop antenna.

The impact that the digital TV services might have on the LTE base stations and user equipment (UE) will also be investigated.

Although the original dividend date was planned for 2016, there will now be a staggered switch off between 2015 and 2018 and so a number of analogue transmitters will continue to be operational, mainly to serve more rural population areas. Analogue TV is therefore included in this study to examine the coexistence during the transition to digital.

The study uses modelling to examine the coexistence of the TV broadcast and LTE services. There are a number of modelling scenarios that will be considered and these are listed below

- LTE base station (BS) interferes with ISDB-T fixed rooftop receivers
- LTE user equipment (UE) interferes with ISDB-T fixed rooftop receivers
- ISDB-T interferes with LTE UE
- ISDB-T interferes with LTE BS
- LTE BS interfering with analogue TV
- LTE UE interfering with analogue TV
- Analogue TV interferes with LTE BS
- Analogue TV interferes with LTE UE

The modelling cases are summarised in Figure 3 below. The wanted signals are indicated by the green arrows while unwanted signals by the red arrows.

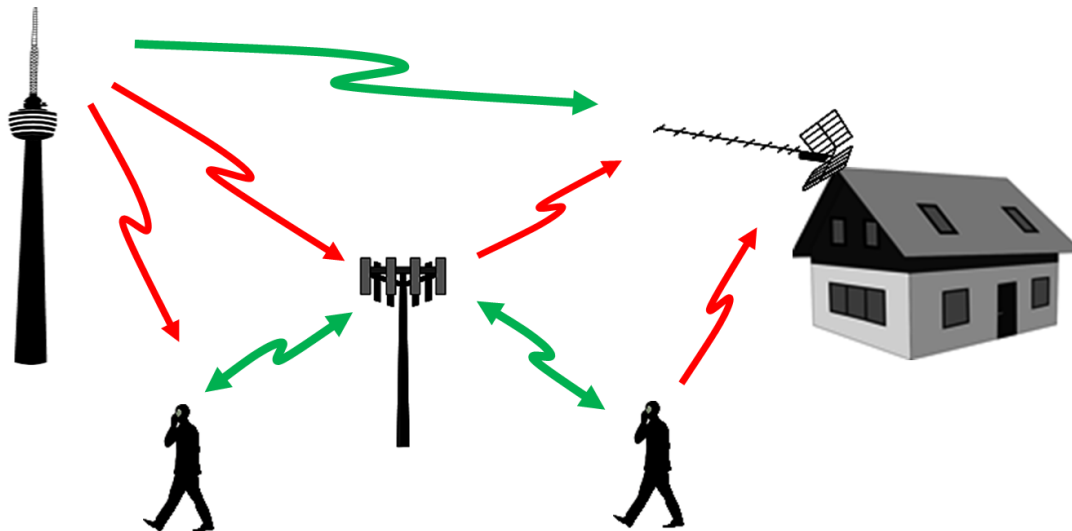

Figure 3: Wanted and Unwanted Paths for the scenarios in the study

The study undertook several types of modelling. The first scenario above used a planning tool to model the interference and the population affected. Three sample areas were considered, Sao Paulo, Brasilia and Campinas. In each area the LTE network was modelled using a representative network based on current mobile base station locations combined with typical emissive characteristics of an LTE network. For the ISDB-T network a representative network based on the existing and future stations following the implementation of the post dividend plan was used for the modelling. The remaining scenarios used the minimum coupling loss³ approach to determine the minimum separation that would be required for each scenario so as not to suffer interference.

For each scenario the analysis will consider two interference mechanisms:

- Out of band interference - this occurs when the unwanted signals, from an adjacent channel to the receiver, are captured by the receiver causing interference with the receiver, so preventing it from decoding the wanted signal without degradation.

³ ERC report 101

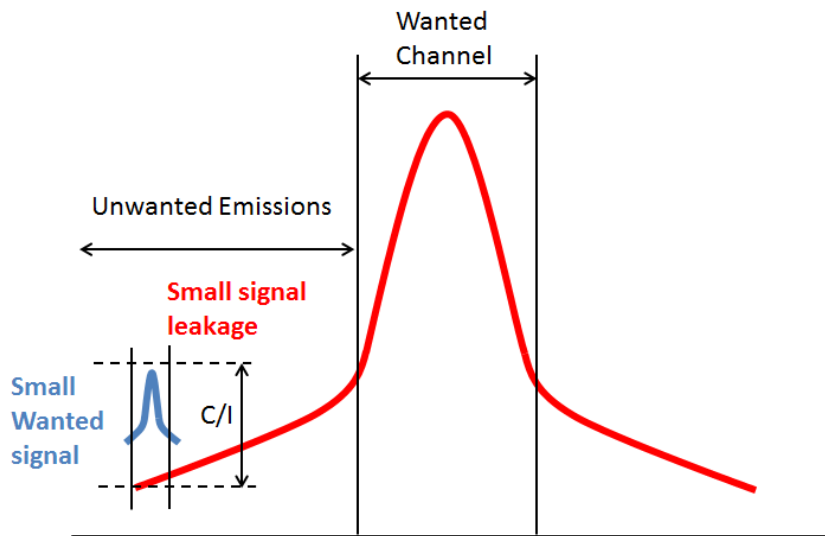

Figure 4: Out of band interference

- Blocking interference - is where a strong unwanted signal prevents the receiver from detecting a wanted signal by driving it into overload. This interference can occur irrespective of the received signal level. The effect is not as frequency selective as out of band interference and can occur when the unwanted signal is many channels away.

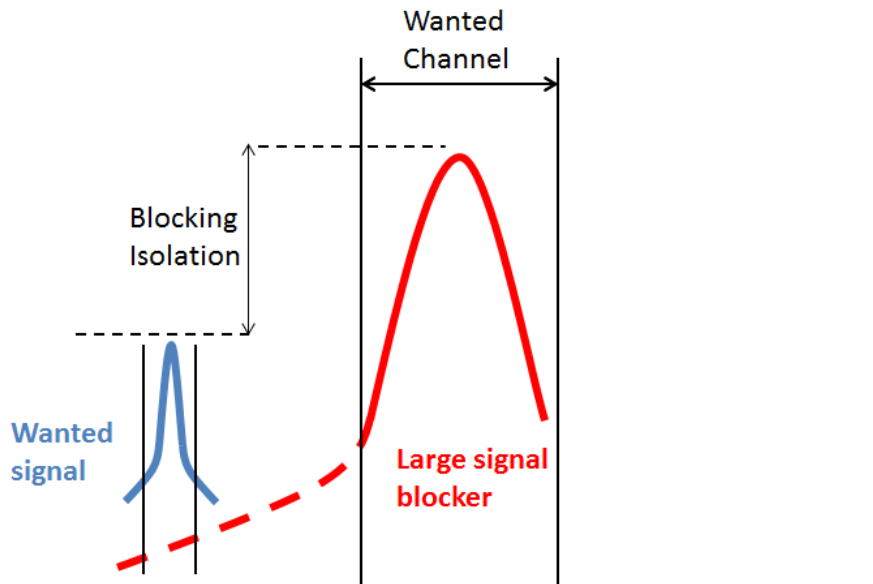

Figure 5: Blocking interference

5 ASSUMPTIONS

To complete the modelling there are a number of key assumptions that are made and these are listed below.

- Only the highest ISDB-T channels (44-51) will be studied for adjacent channel interference and all others are assumed to be better than channel 44.
- All ISDB-T receivers at whatever channel are assumed to suffer from blocking.
- ISDB-T service for fixed rooftop antennas will be modelled at 10m AGL using directional antennas based on Recommendation ITU-R BT.419-3
- This analysis does assume that all of the receiving antennas are directed towards the best server rather than a potential alternative server (which may suffer worse interference.)
- ISDB-T coverage is only assessed over land and coverage over sea is not considered.
- Interference to population in urban areas only will be considered.
- It is assumed that IMT is implemented with LTE technology as per the 3GPP specification.
- 5MHz LTE channels are assumed for the study as this is the smallest channel based on the Anatel channel raster. For network deployment other channel width such as 10 and 20MHz may be used. However the unwanted emissions for the 5, 10 and 20MHz LTE bandwidth system are exactly the same regardless of transmit power since the out of band emissions are defined as emitted power in a measurement bandwidth. This means that interference from LTE into ISDB-T receivers will be similar for 5, 10 and 20MHz LTE transmitters. The transmit power of the 5, 10 and 20MHz LTE systems does vary slightly with transmit power of 20MHz LTE systems generally being slightly less than the 5 and 10MHz transmit powers.
- A single network shall be modelled for an LTE operator, and is considered representative of all other networks.
- LTE will only be considered at existing cellular sites with a single common 3 sector radiation pattern (with sectors aligned at 0, 120 and 240 degrees.)
- LTE polarisation of emission is assumed to be mixed due to use of dual slant antennas. Therefore the polarisation discrimination afforded to the broadcast antenna shall be assumed to be 3dB.
- MFN interference (intra/intra network/MUX) of the ISDB-T network will not be considered, as it is assumed the network has been designed to perform correctly.

- Where protection ratios for given channel separation are not available the worst will be taken on either side.
- Where adjacent channel analysis is performed, the interfering power is considered as the power sum of all signals from any LTE base station.
- Blocking power is considered as the worst case from a single base station only. So additive effects are ignored as it is assumed that the level is so high from the local source as to negate additive effects.
- An LTE base station is radiating at maximum power (in reality power control and other factors will affect this)
- No strong secondary reflections from terrain will be taken into account for coverage and interference calculations.
- TV station data will be based upon station data held by the regulator, Anatel and publically available on their website⁴
- In the absence of digital TV data existing analogue site and antenna details will be used and are assumed to be representative of digital TV post switchover. The power of the analogue transmitter will be reduced by 13dB⁵ to give a representative digital emission power.
- If no antenna height is listed on the Anatel website the antenna height from the station at the same or closest position with a known antenna height will be used.
- Interference areas will be reported for urban area as defined in IBGE (Instituto Brasileiro de Geografia e Estatística) data⁶
- For each modelling area TV stations within 30km of the centre of the study area will be included
- Protection ratio data will be taken from ITU document 4-5-6-7/146-E⁷ for LTE and digital TV.
- The analogue TV and LTE services are considered to be geographically separated, rather than serving the same area, and so blocking is not considered.
- The analogue TV modelling assumes maximum radiated power and minimum coupling loss.

⁴ <http://sistemas.anatel.gov.br/siscom//ConsPlanoBasico/ListaArquivos.asp?SISQsmodulo=14611>

⁵ Derived from the difference between Analogue (Anatel Resolucao 284-2001) and Digital (Anatel Resolucao 398-2005 Anexo 1) powers.

⁶ http://downloads.ibge.gov.br/downloads_geociencias.htm

⁷ Technical Parameters of DTTB System C (ISDB-T) for sharing and compatibility studies between the broadcasting service and the mobile service under WRC-15 Agenda items 1.1 and 1.2

6 METHOD OVERVIEW

The following diagram summarises the main steps in the method. The text thereafter gives an overview of each step. Further details can be found in the method statement⁸. The Interference to analogue TV from LTE is considered separately after the digital case.

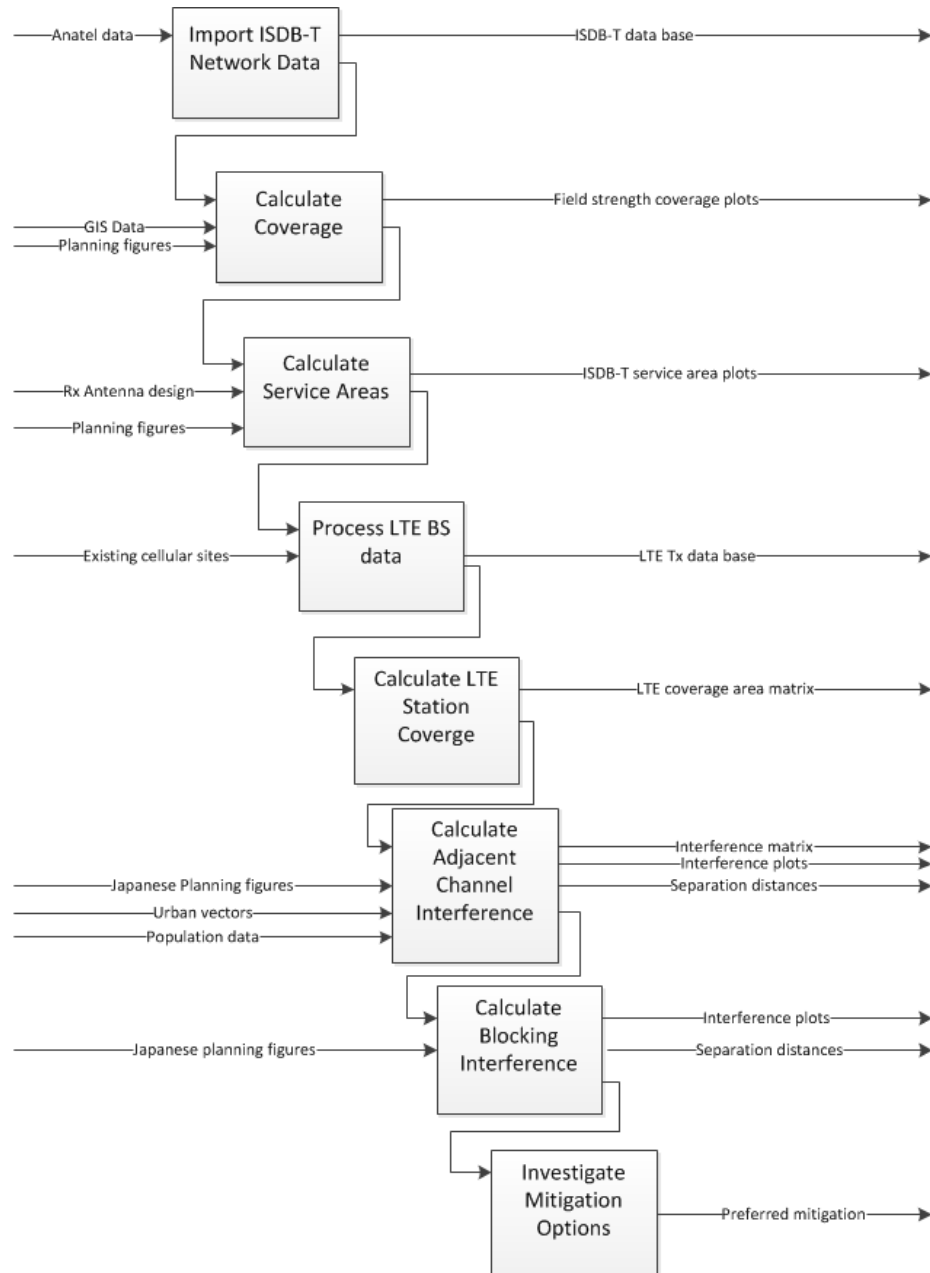

Figure 6: Method Overview

⁸ Method statement for an LTE and ISDB-T coexistence study. August 2013

6.1 CAPTURE ISDB-T TRANSMITTER NETWORK DATA

The ISDB-T transmitter data will consist of data imported from the Anatel website and will be made up of a mixture of the existing analogue and digital stations. The post dividend plan specifications will be applied to these stations to produce the digital plan. Parameters will be used based on the existing data. The exception is where an analogue station migrates to a digital station. In this case the analogue power will be reduced by 13dB⁹ to provide a representative transmit power for the digital station.

6.2 CALCULATE ISDB-T COVERAGE

In this step the field strength coverage for the ISDB-T transmitter stations will be calculated. The coverage calculation will be performed using the terrain (50m resolution based on SRTM¹⁰ data and a morphological data set derived from Landsat5 imagery¹¹. For wanted coverage the ITU-R P. 1546-4 propagation model at 50% locations and time shall be used for coverage predictions. For unwanted coverage the propagation model JTG5-6 will be used with 1% time. This model is a hybrid of ITU P.1546-4 and an extended Okumura-Hata model. It is specifically designed for interference between base stations and fixed or mobile ISDB-T systems. The model is described in detail in the ITU document 5-6/107-E¹².

The following parameters and criteria shall be applied to this modelling:

- Rooftop receiver antenna of 10m above ground level
- Notional urban/suburban clutter height of 10m
- Terrain clearance angle applied to account for terrain shadowing
- Modelling areas limited to Sao Paulo, Brasilia and Campinas only.

A mid-band UHF frequency of 600MHz will be assumed with field strength corrections made for station frequencies above and below this.

The minimum field strength to be used will be 51dB μ V/m. This is based on Anatel resolution 398/2005¹³ which states that broadcast digital is protected to the 51dB μ V/m contour for 50% locations probability.

⁹ Derived from the difference between Analogue (Anatel Resolucao 284-2001) and Digital (Anatel Resolucao 398-2005 Anexo 1) powers.

¹⁰ Shuttle Radar Topography Mission

¹¹ Satellite imagery

¹² ITU JTG 5-6, Document 5-6/107-E –“ Updated Joint Task Group 5-6 propagation model” , November 2009

¹³ ANEXO À RESOLUÇÃO N.º 398, DE 7 DE ABRIL DE 2005

Typically the locations probability when planning TV broadcast services to fixed rooftop antennas will exceed 50% locations (the median case). It is more usual to have a wanted service planned in the range 70% to 95% locations probability. The modelling will therefore calculate the coverage assuming 95% locations probability to allow comparison with the median (50% locations) case.

The 95% locations probability will be calculated by applying a location correction factor to the median value. Applying this locations correction factor of 9dB¹⁴ gives a minimum field strength required for 95% location of 60dBμV/m. A brief explanation of the concept of locations correction factor is discussed in Appendix A. The results for the 95% locations is shown in Appendix B

As the ISDB-T service will be delivered to fixed rooftop antennas, predictions on water will not be made. The outcome of this process is a field strength prediction for each ISDB-T transmitter station.

6.3 CALCULATE SERVICE AREAS

The purpose of this calculation is to establish for every pixel, representing a potential domestic antenna installation, from which station the service is received. In addition the orientation of the antenna is derived in order to compute the discrimination afforded to interference in other directions.

Typically, a receiver antenna will be installed such that it is pointing in the direction of the strongest signal from any available transmitter. In order to determine antenna pointing, a best server analysis will be computed to determine the service area. This shall be achieved by displaying the best server footprint of each ISDB-T transmission site, this process assesses each coverage point in turn and determines the highest margin in excess of the median field required from the predicted field strength for that point and the site that is providing it. The antenna pattern for a receiver antenna shall be taken from the ITU-R BT 419-3. Shown below is a diagram denoting what will be applied.

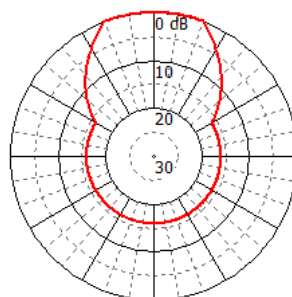

Figure 7: ITU-R BT.419-3 Antenna Pattern

¹⁴ ANEXO À RESOLUÇÃO N.º 398, DE 7 DE ABRIL DE 2005

6.4 PROCESS LTE BS DATA

The base station location data will be downloaded from the Anatel website¹⁵ based on the 850MHz band. From this data a typical Brazilian mobile operator network will be produced. The assumption is that these base station locations are representative of a future LTE network.

The data provided contains information about station location and antenna heights. This data will be used as a base model for a future LTE network.

General LTE station parameters used to represent a typical configuration.

- Nominal power: 2x40W
- Antenna (3 sectors): Kathrein 800 10736
 - (65 degrees beamwidth dual slant polarisation)
- Antenna gain: 16 dBi
- 1dB losses
- Channel Bandwidth: 5MHz

6.5 CALCULATE LTE STATION COVERAGE

In this step the coverage for the LTE base stations will be calculated. In a similar manner to ISDB-T, coverage will be calculated with 50% time and locations for wanted coverage using ITU-R P.1546 and 50% locations and 1% time for unwanted coverage using JTG5-6 (this model is a hybrid of ITU-R P.1546 and an extended Hata model.)

The following parameters and criteria shall be applied to this modelling:

- Receiver antenna of 1.5m above ground level
- Notional urban/suburban clutter height of 10m
- Terrain clearance angle applied
- Modelling areas limited to Sao Paulo, Brasilia and Campinas City areas only.

The outcome of this process will be a field strength coverage plot for each LTE base station.

¹⁵<http://sistemas.anatel.gov.br/stel/Consultas/RecuperacaoFrequencias/tela.asp?SISQsmodulo=9896>>

6.6 CALCULATE ADJACENT CHANNEL INTERFERENCE

Adjacent channel interference will be evaluated for the following scenarios (the output for each of the scenarios is also shown):

1. LTE base station interferes with fixed rooftop ISDB-T. Interference areas and population affected¹⁶ in urban areas¹⁷ will be calculated.
2. LTE UE interferes with fixed rooftop DTV – minimum separation distance
3. ISDB-T interferes into LTE BS – minimum separation distances calculated.
4. ISDB-T BS interferes with LTE UE - minimum separation distances calculated

The frequency separation varies for the different scenarios based on the post dividend spectrum plan (see Figure 8). For example in the case of the LTE base station transmitter there is a minimum of 60MHz of separation to the ISDB-T receiver.

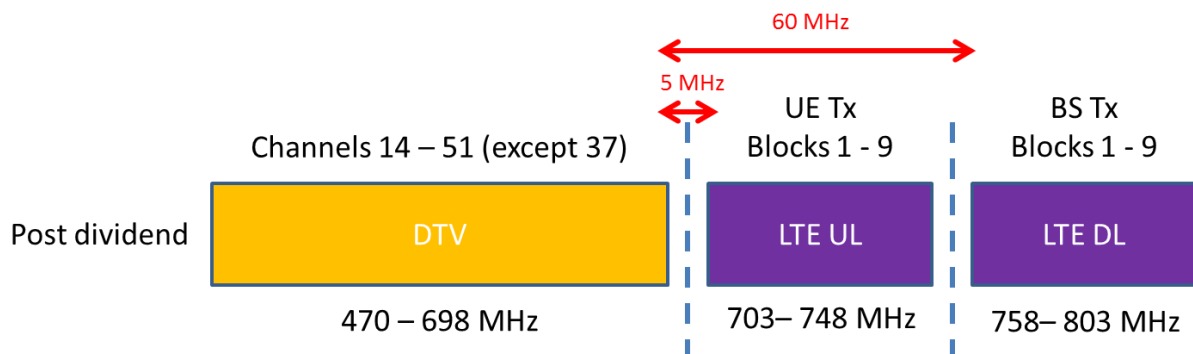

Figure 8: Post dividend spectrum plan

Table 1 also represents this arrangement and shows the channel number for the digital TV and also the frequency blocks for the LTE, both uplink and downlink. The number of channels of separation from the ISDB-T to the LTE system is indicated in the table. The interference will be assessed for the TV channels 51 to 44 and LTE block 1 (as this will be the worst case) for each of the cases taking into account the minimum frequency separation based on the spectrum plan.

¹⁶ IBGE website <http://downloads.ibge.gov.br/downloads_geociencias.htm>

¹⁷ IBGE website <http://downloads.ibge.gov.br/downloads_estatisticas.htm>.

TV Channel offset (number)		ISDB-T							
		Channel (#)	51	50	49	48	47	46	45
LTE	Channel	F (MHz)	695	689	683	677	671	665	659
Uplink	FDD1#UL	703	1	2	3	4	5	6	7
	FDD2#UL	708	2	3	4	5	6	7	8
	FDD3#UL	713	3	4	5	6	7	8	9
	FDD4#UL	718	3	4	5	6	7	8	9
	FDD5#UL	723	4	5	6	7	8	9	10
	FDD6#UL	728	5	6	7	8	9	10	11
	FDD7#UL	733	6	7	8	9	10	11	12
	FDD8#UL	738	7	8	9	10	11	12	13
	FDD9#UL	743	8	9	10	11	12	13	14
Downlink	FDD1#DL	763	11	12	13	14	15	16	17
	FDD2#DL	768	12	13	14	15	16	17	18
	FDD3#DL	773	13	14	15	16	17	18	19
	FDD4#DL	778	13	14	15	16	17	18	19
	FDD5#DL	783	14	15	16	17	18	19	20
	FDD6#DL	788	15	16	17	18	19	20	21
	FDD7#DL	793	16	17	18	19	20	21	22
	FDD8#DL	798	17	18	19	20	21	22	23
	FDD9#DL	803	18	19	20	21	22	23	24

Table 1: Channel separation for ISDB-T to LTE

In order to calculate the interference the protection ratio needs to be known. The protection ratio is defined as the minimum ratio between the wanted and the unwanted signal to ensure error free reception. This is shown in below.

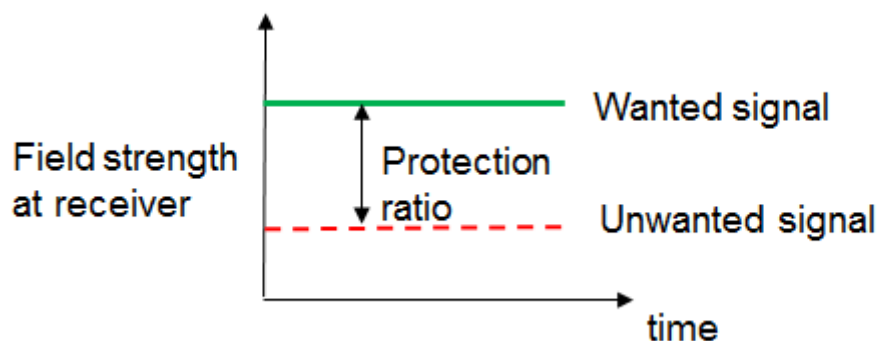

Figure 9: Protection ratio between wanted and unwanted signal

The protection ratios given below are derived from JTG4567/146E¹⁸. These are based on interference from a 10MHz LTE channel. However, as previously stated in the assumptions (section 5), the unwanted emissions for the 5, 10 and 20MHz LTE bandwidth system are exactly the same regardless of transmit power since the out of band emissions are defined as emitted power in a measurement bandwidth. So we can use these values with the 5MHz channel bandwidth that has been assumed for this study.

For frequency offsets in between the values in the source document Where protection ratios for given channel separation are not available the worst case on either side has been used. The figures in the table below show the median (50% locations) case and 95% locations (see Appendix A for further details).

TV Channel offset number	DL Protection Ratio (dB)		UL Protection Ratio (dB)	
	50% locations	95% locations	50% locations	95% locations
1	-23	-10	-4	9
2	-35	-22	-10	3
3	-35	-22	-10	3
4	-36	-23	-33	-20
5	-36	-23	-33	-20
6	-37	-24	-50	-37
7	-36	-23	-33	-20
8	-36	-23	-33	-20
9	-36	-23	-33	-20
10	-36	-23	-33	-20
11	-36	-23	-33	-20
12	-36	-23	-33	-20
13	-36	-23	-33	-20
14	-36	-23	-33	-20
15	-36	-23	-33	-20
16	-36	-23	-33	-20
17	-36	-23	-33	-20
18	-38.9	-26	-46.9	-34
19	-38.9	-26	-45.8	-33

Table 2: Protection Ratio Values for 50% and 95% locations

The channel number shown in the table above corresponds to the number of channels of separation as defined in Table 1 above.

¹⁸ ITU Radiocommunication Study Groups Document 4-5-6-7/146E, 5th July 2013

For scenario 1, where the LTE base station is interfering with the ISDB-T receiver, the interference areas will be calculated. The resulting population in the interference areas which are defined as urban areas¹⁹ will also be calculated. The population data is taken from the 2010 census data²⁰.

The same will also be repeated for 95% locations as well.

6.7 CALCULATE BLOCKING INTERFERENCE

Receiver blocking is where a strong unwanted signal prevents the receiver from detecting a wanted signal. This interference can occur even when the wanted signal is high and the effect is not as frequency selective as adjacent channel interference. Blocking by its very nature requires a large signal and so is most likely to occur in close proximity to the base stations.

The blocking interference analysis will be undertaken for the whole band for the both ISDB-T and LTE frequency blocks.

The receiver blocking threshold, also called overload threshold, is defined as the maximum interfering signal level (in dBm) that can be tolerated by a receiver before it loses the ability to discriminate against unwanted signals at adjacent frequencies.

The blocking values for ISDB-T receivers shown in Table 3 are taken from ITU document 4-5-6-7/146-E

¹⁹ IBGE website <http://downloads.ibge.gov.br/downloads_geociencias.htm>

²⁰ IBGE website <http://downloads.ibge.gov.br/downloads_estatisticas.htm>

TV Channel offset (#)	DL Overload Threshold (dBm)	UL Overload Threshold (dBm)
1	-12	-20
2	-10	-18
3	-10	-18
4	-8	-16
5	-8	-16
6	0	-16
7	-8	-16
8	-8	-16
9	-8	-16
10	-8	-16
11	-8	-16
12	-8	-16
13	-8	-16
14	-8	-16
15	-8	-16
16	-8	-16
17	-8	-16
18	0	-6
19	0	-7

Table 3: Blocking powers

Blocking values for LTE (for E-UTRA operating band 28) taken from the 3GPP standard²¹ are given below.

Base station

- -43 dBm (in band, 683 to 758MHz)
- -15 dBm (outside above frequencies)
-

User Equipment

- -56 dBm (748 to 813MHz)
- -44 dBm (698 to <748MHz and >813 to 863MHz)
- -30 dBm (673 to <698MHz and >863 to 888MHz)
- -15 dBm (outside above frequencies)

The output of this task identified the areas around the transmitters where blocking might potentially occur.

²¹ 3GPP TS 36.104

6.8 ANALOGUE INTERFERENCE ASSESSMENT.

As there will be a staggered switch off of the analogue equipment there will be the situation where LTE systems are deployed and analogue TV is still broadcasting.

6.8.1 LTE interferes with Analogue TV

The analogue TV interference scenario considers the LTE mobile and the base station interfering with the domestic receiver as depicted in the diagram below.

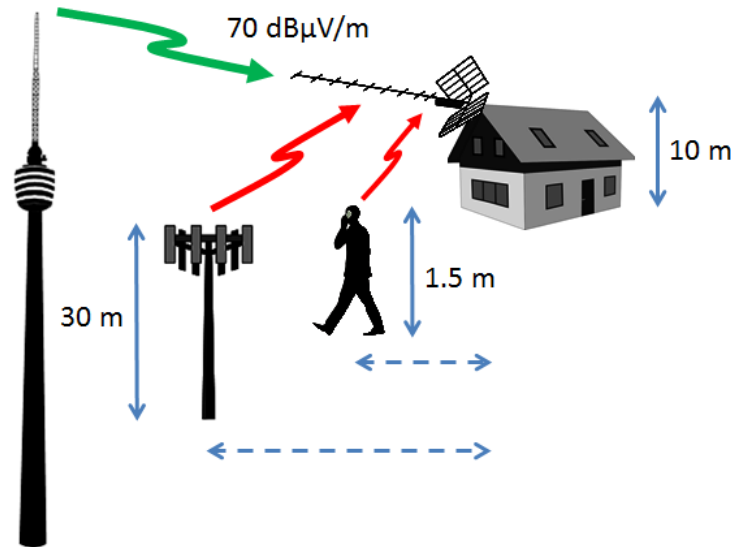

Figure 10: Minimum separation distance

In order to coexist, the services are considered to be geographically separated, rather than serving the same area, and are modelled using maximum radiated power and minimum coupling loss. The worst case situation was envisaged with maximum base station radiation into the beam of the domestic receiver, and similarly outdoor interference from the mobile into the external antenna main beam.

6.8.1.1 Method for assessment of interference

Notably absent from the ITU or any ANATEL regulation, are the protection criteria for LTE into Analogue TV. The reason is clearly because analogue TV is being phased out world-wide, so there is generally little motivation to invest any effort in the production of any useful planning data. Whilst measurements are desirable, this would require considerable effort beyond the scope of this report.

Instead existing protection data is used and the mathematical theory of model equivalence is proposed, because the impact of LTE is known upon digital TV, and in turn, the impact of digital TV is known upon analogue TV. Therefore, it is possible to deduce an equivalent emission of LTE upon analogue TV in terms of modified form digital TV being a proxy for LTE interference into analogue

To do this, the method is to:

- (i) Compute the difference between the protection ratio from digital TV into digital TV and from digital TV into analogue TV, which gives an equivalence correction figure.
- (ii) Take digital figures for LTE into digital TV and add the equivalence correction figure.

6.8.1.2 Protection criteria

The ANATEL resolutions state that the analogue broadcast signal is protected to the 70 dB μ V/m contour in an urban environment. With analogue TV plans, the convention is for protection to be afforded to fixed rooftop antennas at a nominal height of 10m.

The protection ratios are expressed in resolution 398²² and are summarised in Table 4 below.

	Protection ratio for analogue TV interfered by digital (dB)	Protection ratio for digital TV interfered by digital (dB)	Digital equivalence correction figure (dB)
n (co-channel)	34	19	-15
n \pm 1 (adjacent)	-11	-24	-13
n \pm 7 (local oscillator)	-24		-36
n \pm 8 (intermediate frequency)	-25		-35
n+14 (audio image)	-24		-36
n+15 (video image)	-22		-38

Table 4: Analogue and digital TV protection ratios with digital equivalence figure

²² <http://legislacao.anatel.gov.br/resolucoes/2005/288-resolucao-398> (accessed October 2013)

The table shows the co-channel protection ratios for the digital into digital and digital into analogue are 19 and 34dB, so the equivalence correction figure for our model should be -15dB. Concerning adjacent channels, the factor for the upper and lower is -13dB. For the special cases of the intermediate, local oscillator and image channels, these are negligible for the digital case, but significant for the analogue. Assuming that a digital receiver has a dynamic range no greater than 80 dB then one could assume that a protection ratio of less than -60dB on an adjacent channel is a sensible floor. This would imply an adjustment factor of -35, -36, -38dB for the intermediate, local oscillator/audio image and video image channels respectively. For adjacent channels not measured, the equivalence figure for the first adjacent channel is assumed.

To determine the protection ratio to be used as a proxy from LTE to analogue TV, we need to add the equivalence factor computed above with the protection ratio for digital TV, as taken from the Japanese submission to JTG 4-5-6-7 in respect of WRC 15 Agenda Item 1.1 and 1.2²³.

	Protection ratio for digital TV interfered by	
	LTE Base station (dB)	LTE User equipment (dB)
n (co-channel)	20	19.5
n+1 (9 MHz)	-22.5	-4.2
n+2(15 MHz)	-34.9	-9.8
n+4 (27 MHz)	-36.2	-32.5
n+6(39 MHz)	-37.2	-50.1
n+18 (111 MHz)	-38.9	-46.9
n+19 (117 MHz)	-38.9	-45.8

Table 5: Digital TV protection ratios

The measurements are for discrete channels, and there are some gaps. Unlike analogue TV, modern digital TV receiver designs are likely highly integrated low cost devices that are based upon direct conversion techniques or superheterodyne methods with a high intermediate frequency. This improves performance meaning that protection ratios in band are relatively high compared to analogue, and are largely limited by the adjacent channel leakage of the unwanted system. Since adjacent channel leakage is generally monotonically decreasing with frequency, the worst case protection ratio is chosen from the nearest channels where there are gaps.

²³ ITU Joint Task Group 4-5-6-7 - Document 4-5-6-7/146-E

Applying all of these criteria yields equivalent analogue TV protection ratios considering LTE interference as below:

TV channel offset number	0	1	2	3	4	5	6	7	8	9
Downlink protection ratio (dB)	35	-10	-22	-22	-23	-23	-24	0	-1	-23
Uplink protection ratio (dB)	35	9	3	3	-20	-20	-37	4	3	-20

10	11	12	13	14	15	16	17	18	19
-23	-23	-23	-23	0	2	-23	-23	-26	-26
-20	-20	-20	-20	4	6	-20	-20	-34	-33

Table 6: Equivalent analogue TV protection ratios

Locations correction margin are not applied to the above figures, because whilst a valid concept, it is more applicable to digital TV which degrades quite suddenly in the presence of interference. Analogue TV tends to become gradually noisier rather than suffering catastrophic failure as in the digital case, so the margin is not necessary.

The LTE base station was modelled at a height of 30m with 2 x 40W coupled into a 16 dBi antenna with 1dB system losses, meaning an ERP of -1.1dBkW in each plane (expressed relative a dipole). To model the interference to the fixed antenna, the propagation path was modelled using ITU propagation method 1546 for point-to-area predictions for terrestrial services in the frequency range 30 MHz to 3 000 MHz²⁴, using a modelling frequency of 600 MHz to convert minimum coupling loss into minimum separation distance for interfering field strengths not exceeding 10% of time. This basic method is the same one that is used for SIGAnatel tool used by ANATEL for frequency planning.

The user equipment was modelled as 23 dBm radiating into a 0 dBi antenna, meaning an ERP of -37.1dBkW. Given the short range interference potential due to the low power, a blended version of 1546 and Okumura Hata was used to model the minimum propagation loss in terms of separation distance. This model (JTG56 – see Appendix B) was created by ITU Joint Task Group 5-6 for their work for the purposes of IMT sharing studies, and is specified in Appendix 1 of Annex 6 Chairman’s report²⁵. The path was modelled in reverse, considering the highest antenna as the transmitting station at 10m.

²⁴ ITU Recommendation ITU-R P.1546-3

²⁵ ITU Joint Task Group 5-6 - Annex 6 to Document 5-6/180-E

6.8.2 Analogue TV interferes with LTE

The analogue TV interference with LTE considers the analogue transmitter interfering with the LTE mobile and the base station as depicted in the diagram below.

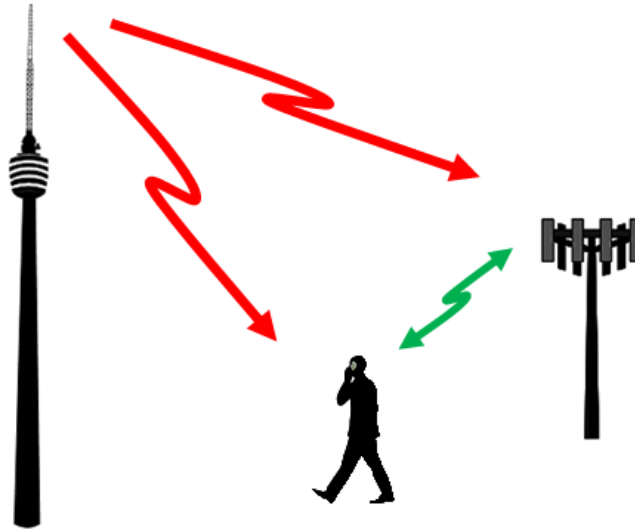

Figure 11: Analogue TV interference scenario with LTE

In order to coexist, the services are considered to be geographically separated, rather than serving the same area. The modelling uses four values of radiating power based on the power classes as specified in Anatel resolution 284 and these are listed below.

Transmitter Class	Power (kW)	Power (dBW)
Special	1600	62
A	160	52
B	16	42
C	1.6	32

Table 7: Analogue TV transmitter power classes

The worst case situation was envisaged with maximum transmitter station radiation into the antenna main beam of the LTE base station and similarly to the LTE mobile.

6.8.2.1 Method for assessment of interference

Absent from the ITU or any ANATEL regulation, are the protection criteria for Analogue TV into LTE. As for the reverse case the reason is clearly because analogue TV is being phased out world-wide, so there is generally little motivation to invest any effort in the production of any useful planning data. Whilst measurements are desirable, this would require considerable effort beyond the scope of this report.

Instead existing protection data is used and the mathematical theory of model equivalence is proposed. We know the impact of digital upon digital TV and the impact of analogue on digital TV. Therefore if we assume that digital TV is as robust as mobile we can say there is an equivalence and can calculate the correction factor to apply to the Analogue TV into LTE situation. The method to complete this is as follows.

- (i) Compute the difference between the protection ratio from digital TV into digital TV and from analogue TV into digital analogue TV, which gives an equivalence correction figure.
- (ii) We will assume that an analogue transmitter is equivalent to the digital one with the equivalence correction figure applied as an additional loss to the results of the ISDB-T into LTE modelling.

The protection ratios, expressed in resolution 398²⁶, are shown in Table 8 along with the equivalence correction figures which are derived from them.

	Protection ratio for digital TV interfered by analogue (dB)	Protection ratio for digital TV interfered by digital (dB)	Analogue equivalence correction figure (dB)
n (co-channel)	7	19	12
n±1 (adjacent)	-26	-24	2

Table 8: Analogue and digital TV protection ratios with analogue equivalence figure

Equivalence correction figures for channels beyond the first adjacent channel are assumed to be the same as the first adjacent channel i.e. 2dB

²⁶ <http://legislacao.anatel.gov.br/resolucoes/2005/288-resolucao-398> (accessed October 2013)

6.9 INVESTIGATE MITIGATION OPTIONS

This task shall identify and assess options to overcome the interference issues. Possible mitigation options that might be investigated are:

Each option identified will be discussed in terms of likely benefits as well as the practicality of the mitigation.

7 RESULTS

The results presented below are split into 3 sections: LTE interference with ISDB-T, ISDB-T interference with LTE and LTE interference with analogue television.

7.1 LTE INTERFERENCE WITH ISDB-T

The section has two sub categories. LTE BS interfering with ISDB-T and LTE UE interfering with ISDB-T.

7.1.1 LTE BS interference with ISDB-T

7.1.1.1 Out of band interference

Sao Paulo

An overview of the ISDB-T transmitters is shown below.

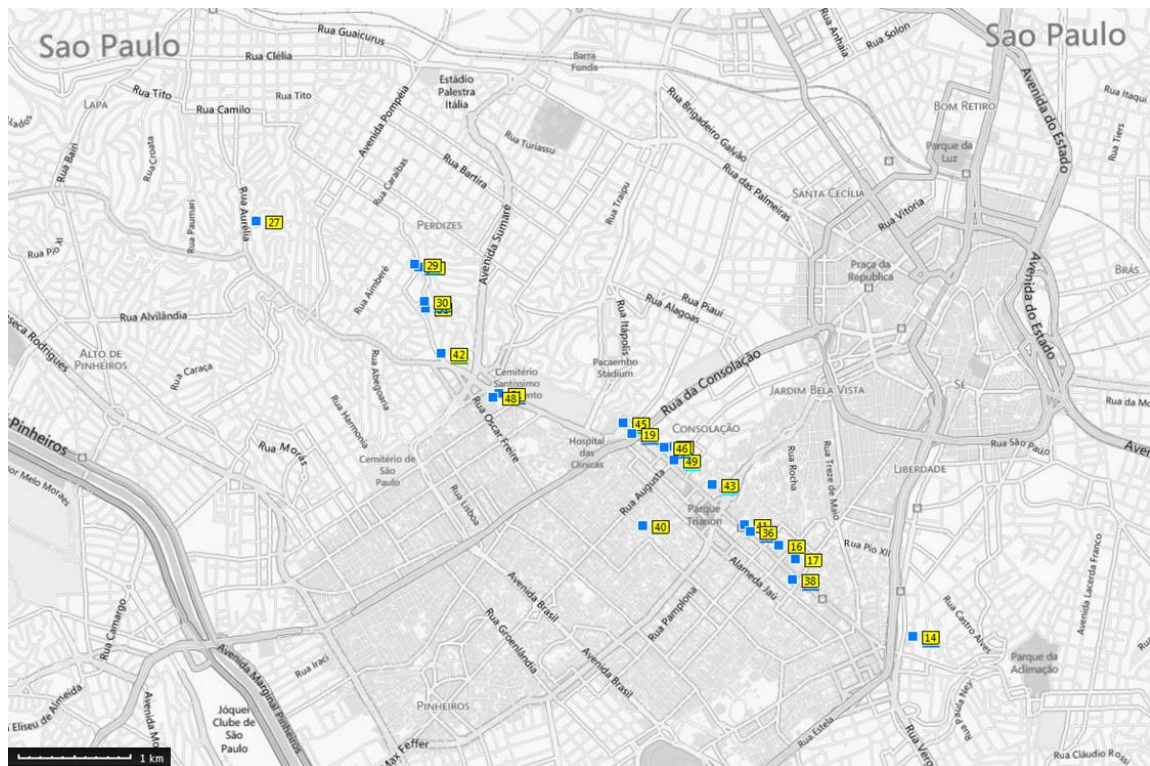

Figure 12: Sao Paulo TV transmitter's location

The wanted service area for each of the TV broadcast channels is shown below. The blue area corresponds to threshold level above 51dB μ V/m (50% locations). The size of the coverage areas vary mainly due to the difference in the radiated powers.

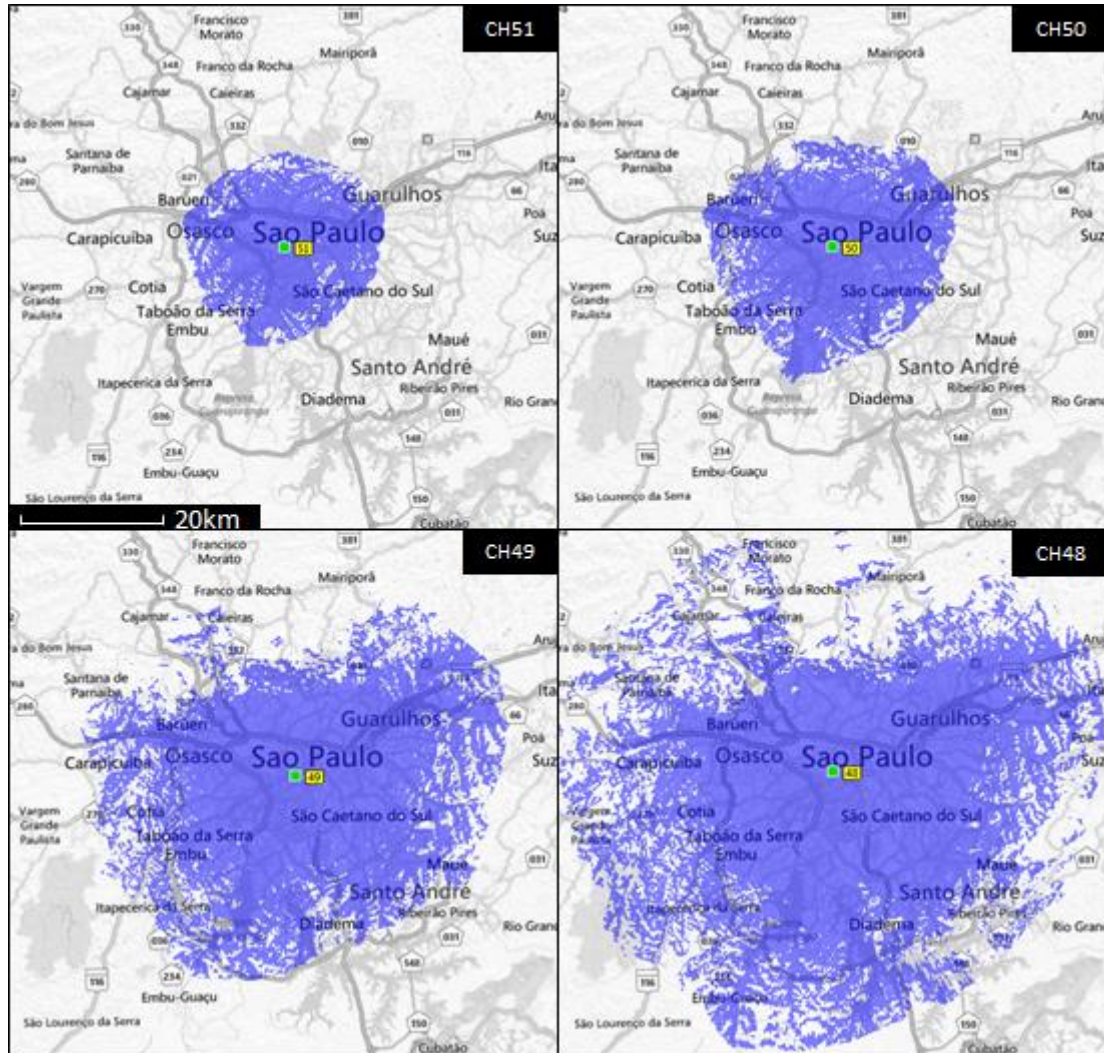

Figure 13: Sao Paulo TV coverage for channels 48 to 51

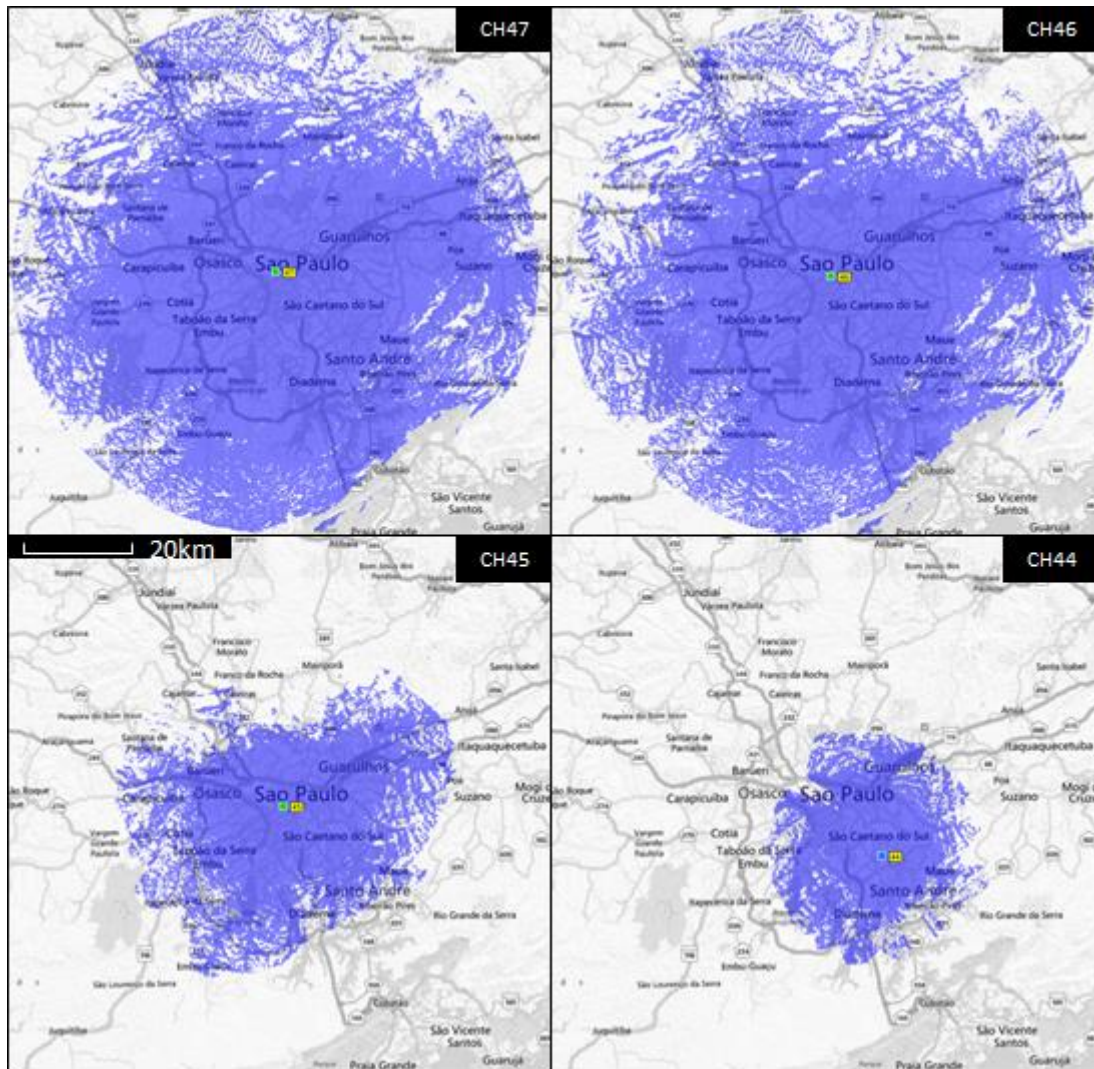

Figure 14: Sao Paulo TV coverage for channels 44 to 47

For each of the channels shown the out of band interference caused by the LTE base stations was predicted.

Table 9 shows the area that is interfered as well as the population affected.

Frequency MHz	Channel number	Separation (MHz) to FDD1 DL	Urban area interfered km2	Population in urban areas interfered	Percentage of population in urban areas interfered
			50% locations	50% locations	50% locations
695	51	60	5.2	52,794	0.1%
689	50	66	2.3	28,042	0.4%
683	49	72	0.7	8,593	0.1%
677	48	78	0.2	2,288	<0.1%
671	47	84	<0.1	66	<0.1%
665	46	90	<0.1	66	<0.1%
659	45	96	0.5	6,316	<0.1%
653	44	102	0.0	0	0%

Table 9: Population and area interfered for Sao Paulo

Urban areas only are considered as these are the only areas that are protected from interference. The results are for the 50% (median) locations value based on the Anatel resolution 398/2005. Results for 95% locations are shown in Appendix C.

Examining the table above channel 51 experiences the most interference and because Sao Paulo is a densely populated city there are over 50,000 people that may be affected even though the predicted interference area is small at 5km². The general trend is for the interference to reduce as the frequency separation between the broadcast and mobile stations increases. However this is not a function of the protection ratios as they are constant at -36dB (median case) for channels 45 to 51 based on the data available. It is actually the transmit power that is having the biggest impact. When the transmit power is high, indicated by the size of the coverage areas in Figure 13 and Figure 14 above, the wanted signal has sufficient margin above the unwanted signal and the interference areas are small. Typically interference is only likely to occur where the wanted is low and the unwanted is high (i.e. predominantly towards the edge of TV service area and close to an LTE base station). For channel 44 the protection ratio increases to -39dB and interference is no longer predicted. For out of band interference it is unlikely that interference will therefore be experienced beyond channel 44.

Brasilia

An overview of the ISDB-T transmitter positions and channel numbers is shown below.

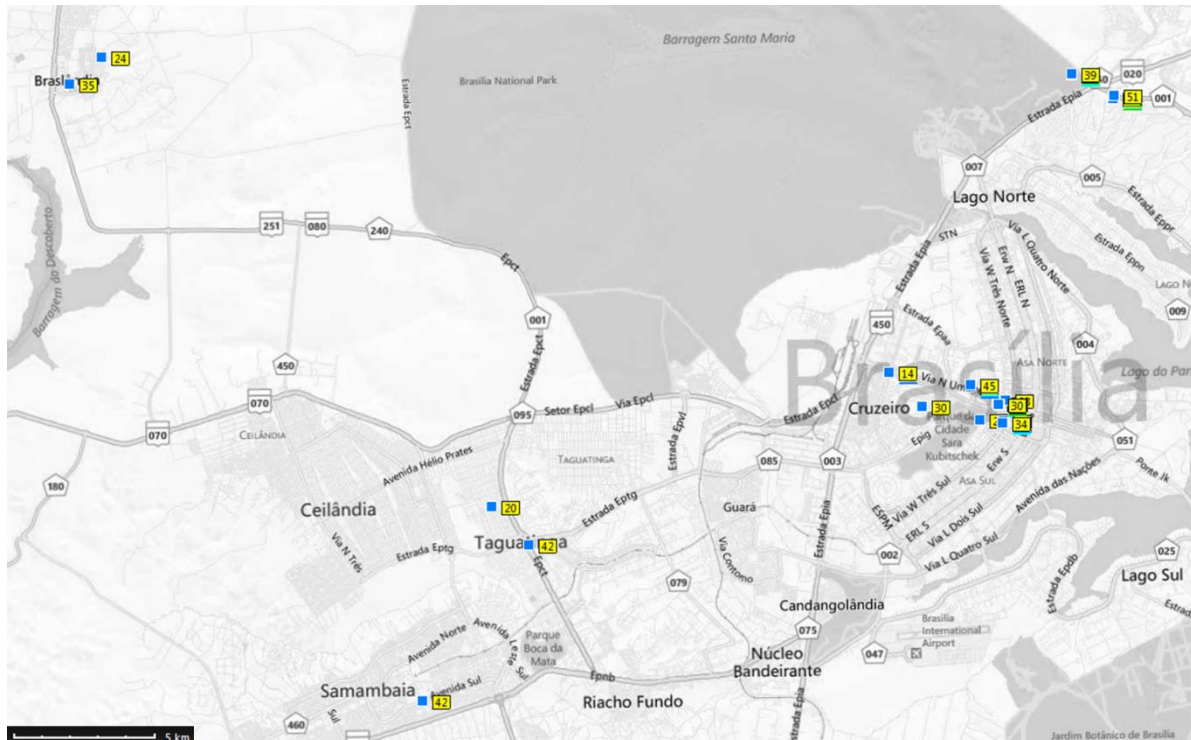

Figure 15: Brasilia TV transmitter's location

The wanted service area for each of the TV broadcast channels is shown below. The blue area corresponds to threshold level above 51dB μ V/m. The size of the coverage areas vary mainly due to the difference in the radiated powers.

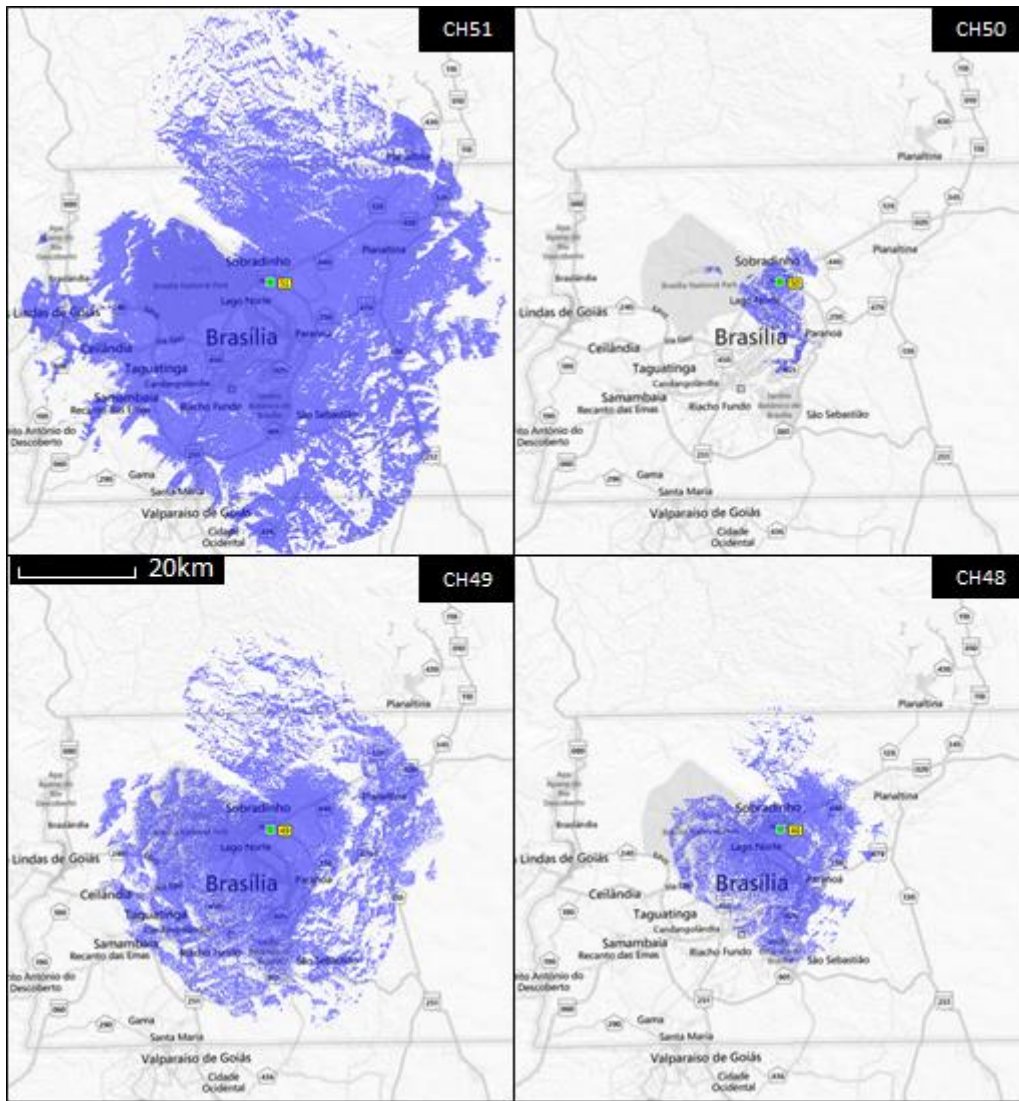

Figure 16: Brasilia TV coverage for channels 48 to 51

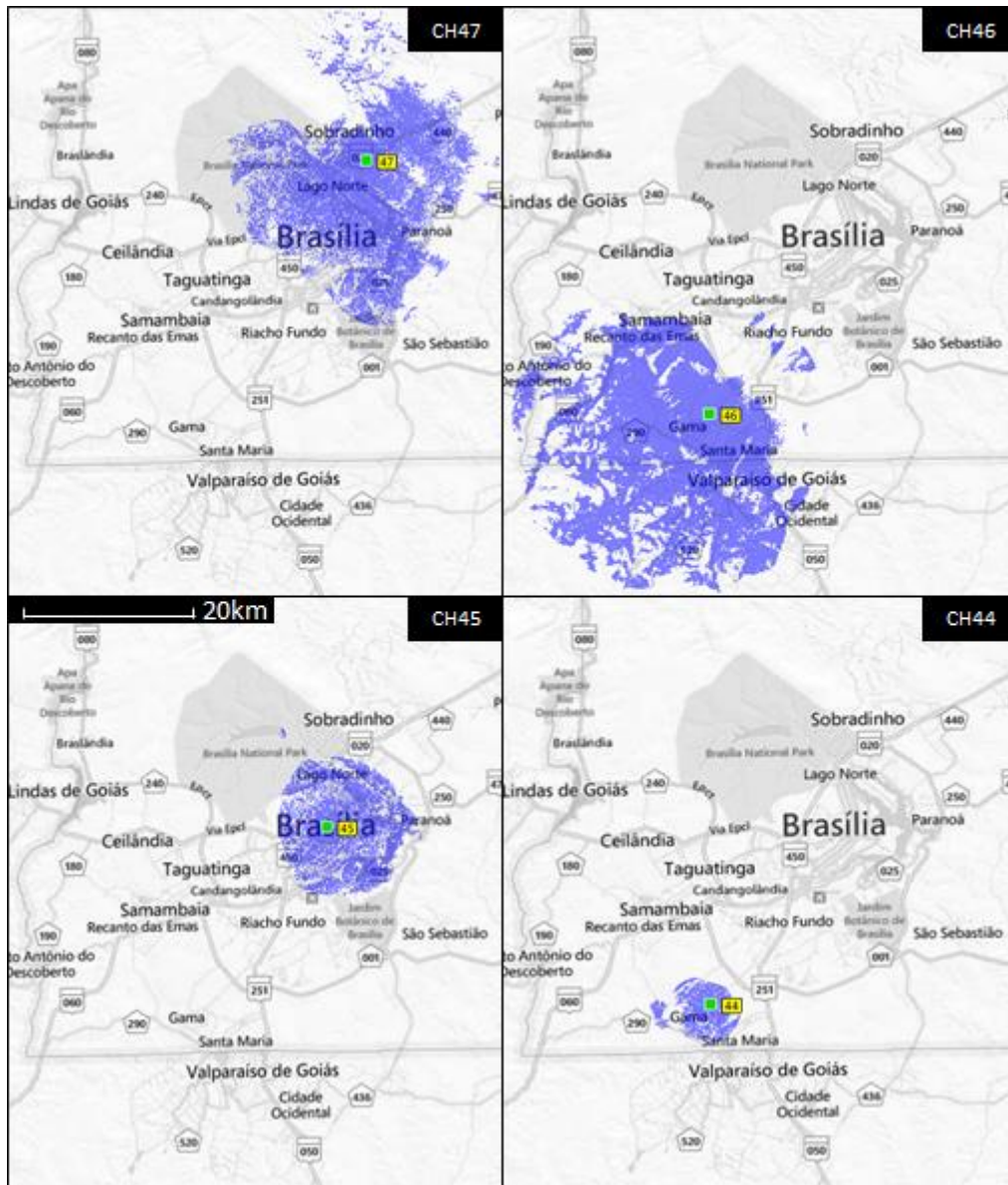

Figure 17: Brasília TV coverage for channels 44 to 47

Table 10 shows for Brasilia the areas that interference is predicted as well as the population affected

Frequency MHz	Channel number	Separation (MHz) to FDD1 DL	Urban area interfered km ²	Population in urban areas interfered	Percentage of population in urban areas interfered
			50% locations	50% locations	50% locations
695	51	60	0.7	4,571	0.2%
689	50	66	0.8	6,949	5.3%
683	49	72	1.7	14,395	1.1%
677	48	78	1.1	4,302	0.9%
671	47	84	1.1	5,044	1.2%
665	46	90	0.2	1,278	0.2%
659	45	96	1.3	3,276	1.3%
653	44	102	<0.1	187	0.2%

Table 10: Population and area interfered for Brasilia

Urban areas only are considered as these are the only areas that are protected from interference. The results are for the 50% (median) locations value based on the Anatel resolution 398/2005. Results for 95% locations are shown in Appendix C. Examining the table the areas of interference and the population affected is generally low with less than 2km² area for each channel. Typically interference is only likely to happen when the wanted signal is low and the unwanted in high (i.e. towards the edge of TV coverage and close to an LTE base station.)The highest population interfered is for Channel 49 for the median case with just over 14,000 affected. The interference does not diminish as the separation increases as one might have expected but this is because the protection ratios used are constant at -36dB (median case) for channels 51 to 45 based on the data available. For channel 44 the protection ratio increases to -39dB and interference predicted is negligible. For out of band interference it is unlikely that interference will be experienced beyond channel 44.

Campinas

An overview of the ISDB-T transmitter positions and channel numbers is shown below.

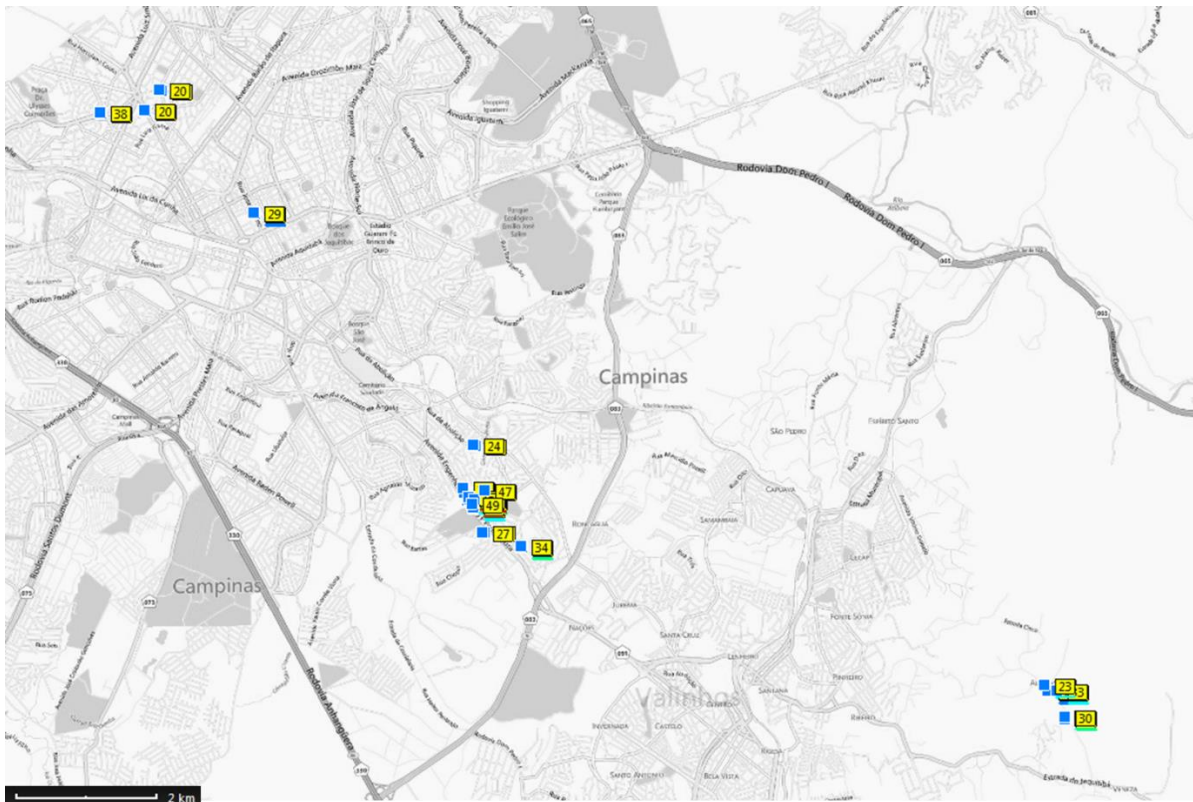

Figure 18: Campinas TV transmitters with channel number

The wanted service area for each of the TV broadcast channels is shown below. The blue area corresponds to threshold level above 51dB μ V/m (50% locations). The size of the coverage areas vary mainly due to the difference in the radiated powers.

Channels 51, 50 and 45 were not used in the study area.

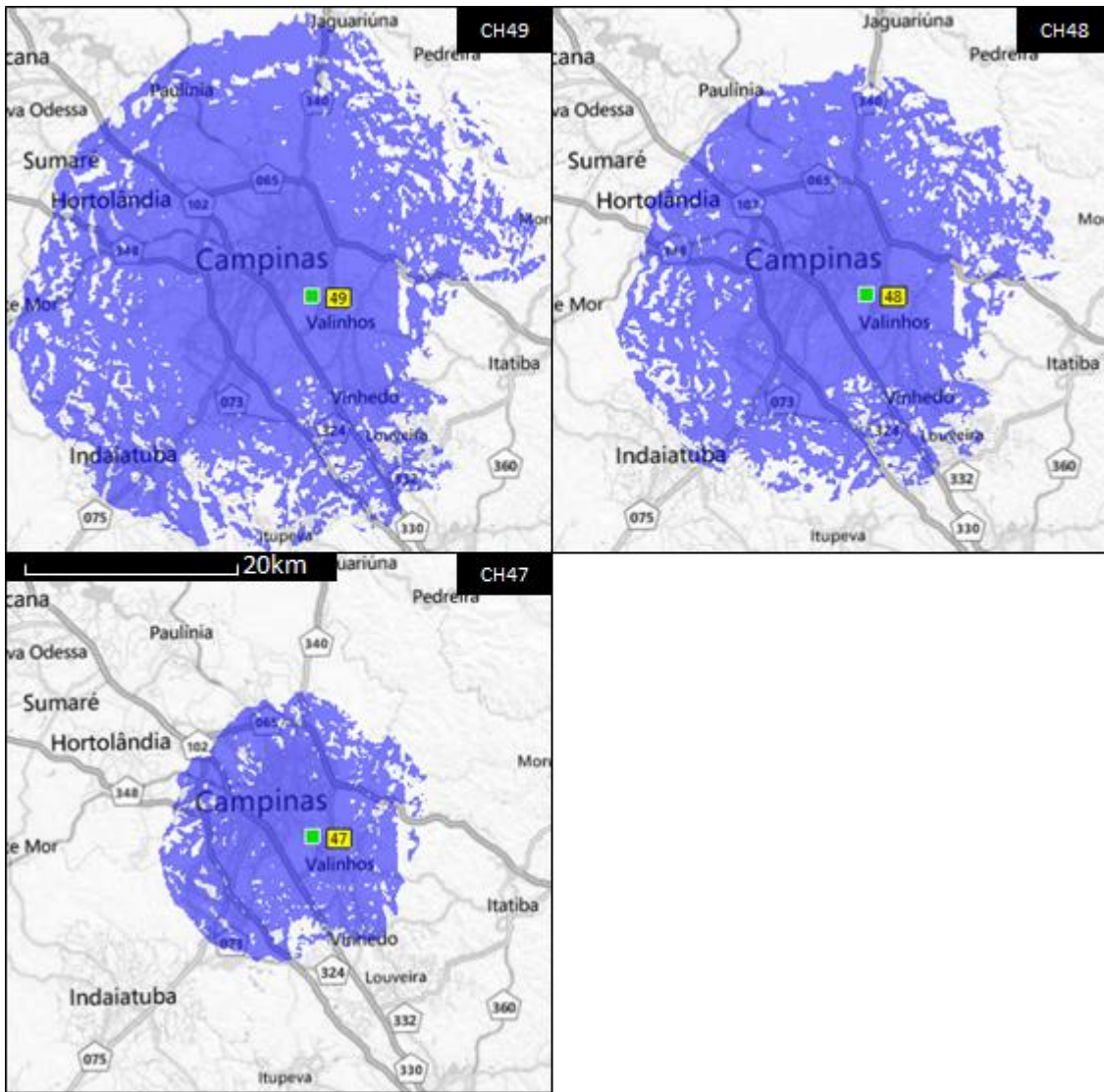

Figure 19: Campinas TV coverage for channels 47 to 49

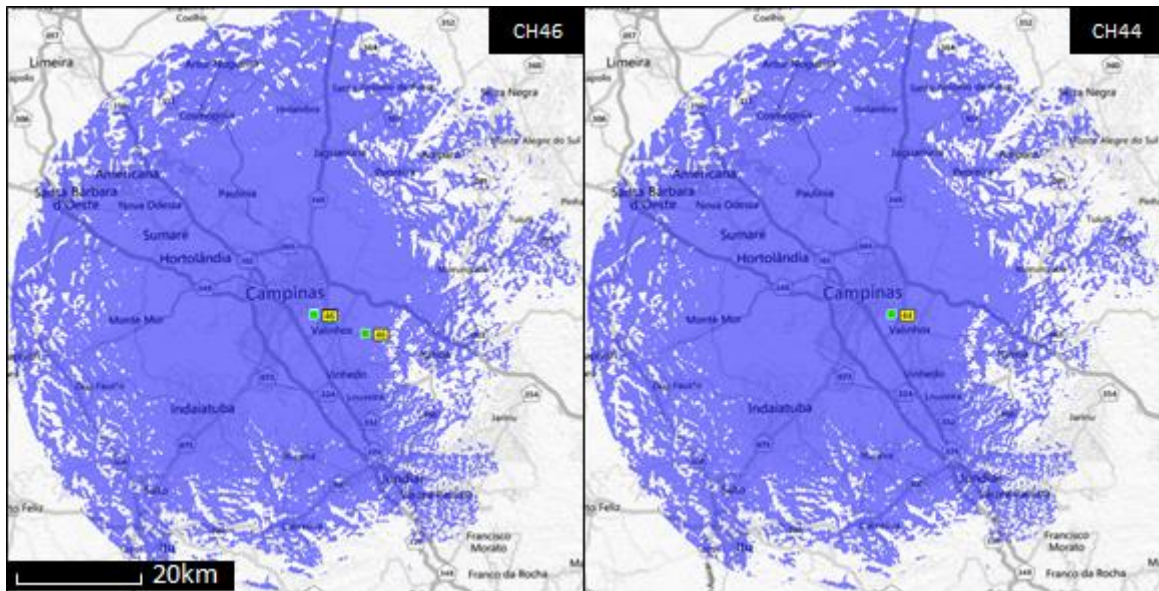

Figure 20: Campinas TV coverage for channels 44 and 46

Table 11 shows the size of the area that is interfered as well as the population affected.

Frequency MHz	Channel number	Separation (MHz) to FDD1#D	Urban area interfered km2	Population in urban areas interfered	Percentage of population in urban areas interfered
			50% locations	50% locations	50% locations
695	51	60	-	-	-
689	50	66	-	-	-
683	49	72	<0.1	39	<0.1%
677	48	78	0.1	307	<0.1%
671	47	84	1.0	2,520	0.3%
665	46	90	<0.1	1	<0.1%
659	45	96	-	-	-
653	44	102	<0.1	0	<0.1%

Table 11: Population and area interfered for Campinas

Urban areas only are considered as these are the only areas that are protected from interference. The results are for the 50% (median) locations value based on the Anatel resolution 398/2005. Results for 95% locations are shown in Appendix C. Examining the table the areas of interference and the population affected is generally low with less than 1km² area for each channel. Again, as for Sao Paulo and Brasilia, interference is only likely to occur where the wanted signal is low and the unwanted

in high (i.e. towards the edge of TV coverage and close to an LTE base station.) Channel 47 has the highest predicted interference area and a population affected of just over 2,500. Again, as for Brasilia, the interference does not diminish as the separation increases as one might have expected but this is because the protection ratios are constant at -36dB (median case) for channels 51 to 45 based on the available data. For channel 44 the protection ratio increases to -39dB and there are no interference areas predicted for the median case. For out of band interference it is unlikely that interference will be experienced beyond channel 44.

7.1.1.2 Blocking

The blocking levels for an ISDB-T receiver between 60MHz and 102MHz separation (channels) is -8dBm²⁷. This is equivalent to a field strength of 117dB μ V/m (assuming 9dBi receiver antenna gain). Analysing the coverage from the LTE base stations there are no areas where this field strength is exceeded. For frequency separation greater than 102MHz the blocking level is 0dBm. Again there are no coverage areas that exceed this value so blocking is unlikely to be a problem.

As a useful comparison the theoretical free space loss separation distance required is 300m and 150m for the two blocking levels above.

Blocking by the LTE base station is unlikely to be a problem.

For interference from the LTE base station into the ISDB-T receiver out of band interference is the limiting case.

²⁷ Table A1.4 - Technical Parameters of DTTB System C (ISDB-T) for sharing and compatibility studies between the broadcasting service and the mobile service under WRC-15 Agenda items 1.1 and 1.2

7.1.2 LTE UE into ISDB-T

7.1.2.1 Out of band

Figure 21 below indicates the minimum separation distances based on the minimum coupling loss for LTE block 1 into channel 51. The separation distances are calculated based on the JTG56 propagation model. Distances shown are based on the maximum and also the median output power (20dB down on max) of the LTE UE.

There are 2 positions of UE shown with the corresponding minimum separation distance. Position 1 is the worst case with the domestic antenna pointing directly at the mobile. In reality the domestic antenna may not be pointing at the mobile, affording up to 16dB of discrimination²⁸ and this is shown by the second position where the mobile is in the street.

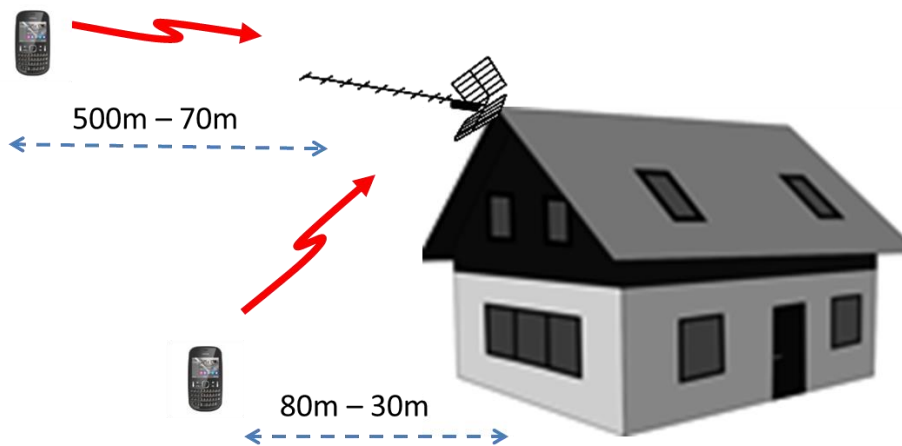

Figure 21: Out of band interference from mobile to TV receiver

For position 1, beyond the first few adjacent channels the separation required drops to between 60m and 10m separation. For position 2 beyond the first few adjacent channels the separation drops to between 50m and 1m for the maximum power and median power respectively.

It is worth remembering that the minimum coupling loss theory assumes that we are operating 3dB above the minimum required field strength which will only occur at the extents of the coverage area. This combined with the specific geometry of any given situation where additional losses such as building entry loss and body losses may apply, will result in the separation distances being further reduced. As a result the potential out of band interference is likely to be low.

²⁸ ITU Recommendation ITU-R BT.419-3

7.1.2.2 Blocking

The blocking level for an ISDB-T receiver in channel 51 is -20dBm. Using the minimum coupling loss with a receiver gain of 9dBi²⁹ the isolation required is 52dB. This equates to a separation distance of about 16m by applying JTG56 propagation model. The figure below shows how the separation distance varies with TV channel number.

As the frequency separation increases so does the blocking level (at channel 48 the level is -16dB) and so the likelihood of suffering blocking diminishes slightly.

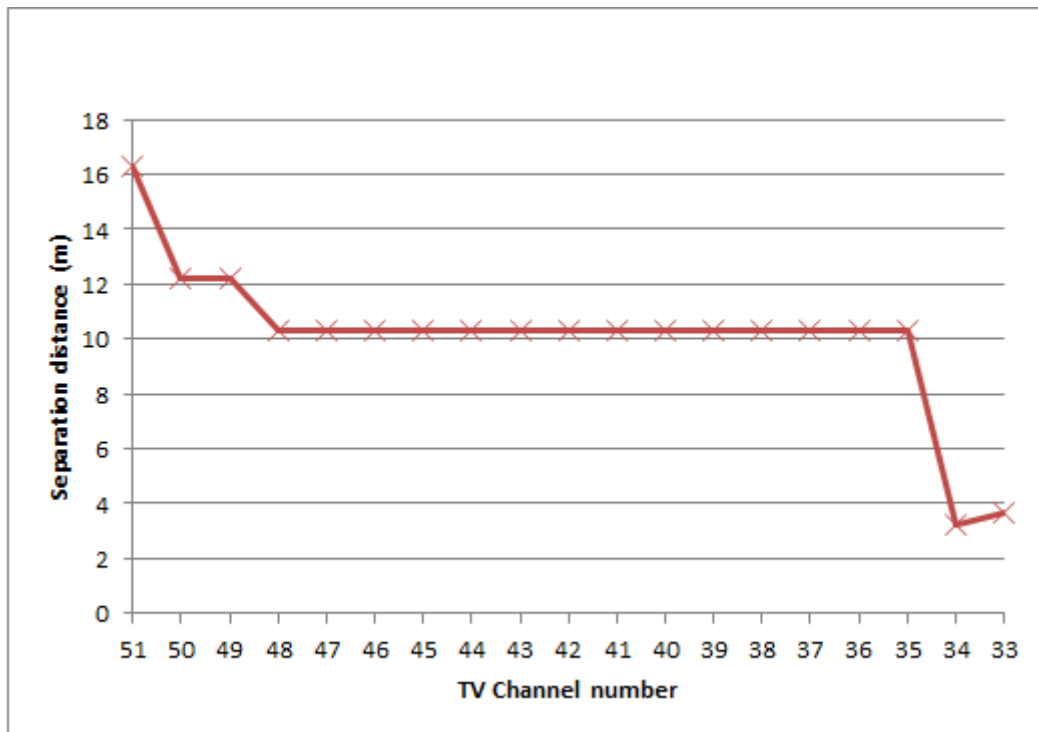

Figure 22: Separation distance against TV channel number

If the median mobile emission is used rather than the maximum power the separation distance required is 2m or less for all TV channels.

Once beyond a few channels of separation blocking distances remain fairly constant and blocking, may in some situations, be the dominant effect over out of band interference. Given the results above, interference caused by blocking is considered to be low probability.

²⁹ JTG4567-C-0126

7.2 ISDB-T INTERFERENCE INTO LTE

7.2.1 ISDB-T into LTE BS

7.2.1.1 Out of band

There are three emission spectrum mask limits that are given in ABNT NBR15601³⁰ and these are shown below.

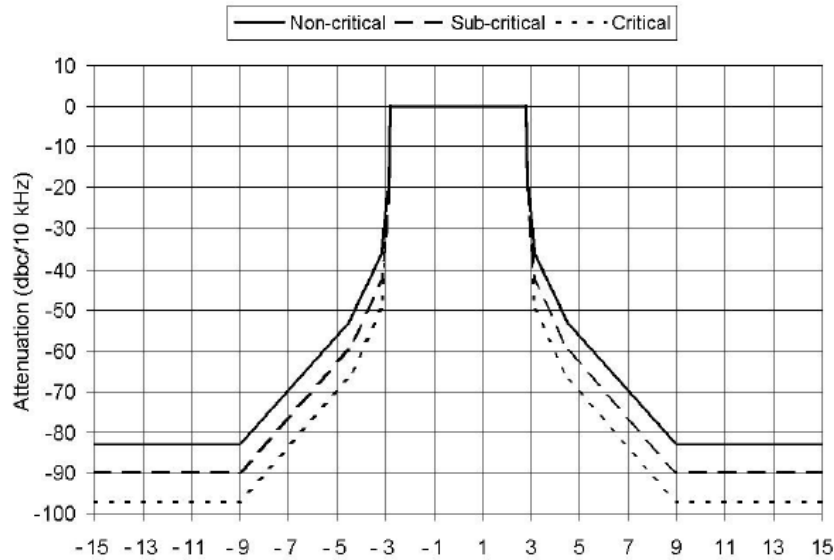

Figure 23: ISDB-T emission masks

The non-critical can be used in the absence of adjacent broadcast channel in the same location. The critical mask is used when emissions need to be minimised to reduce unwanted emissions to an adjacent channel. For successful coexistence between the cellular and broadcast systems reducing the unwanted emissions is obviously preferable so the critical mask is the natural choice. Figure 24 shows the separation distance required after applying propagation model ITU-R P.1546. This assumes a 53dBW transmitter (the highest in the study areas)

³⁰ ABNTNBR15601_2007Vc_2008

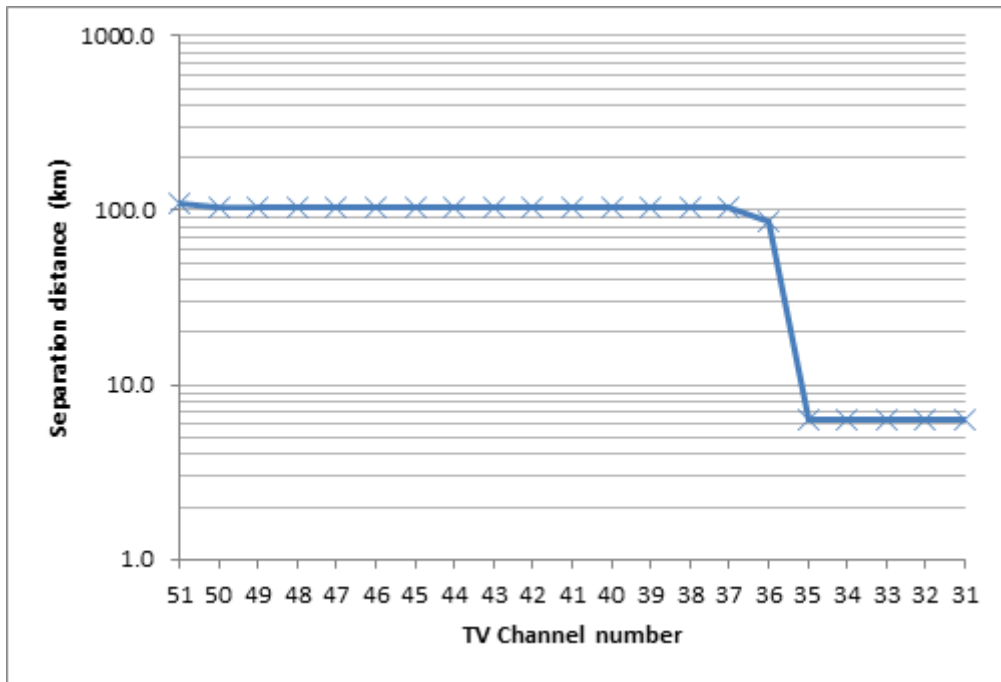

Figure 24: Separation distance required after applying the critical mask

The separation distances are high and suggest that mitigation is required. (See section 8 for mitigation and how this reduces the separation required)

7.2.1.2 Blocking

The blocking level for LTE is -43dBm^{31} for separation of 683MHz to 698MHz (channels 49 to 51). Beyond 683MHz the blocking level is -15dBm . Using the minimum coupling loss and assuming 53dBW transmitter with a 16dBi receive antenna, this requires an isolation of 142dB ($53 + 30 + 16 + 43$) and 114dB ($53 + 30 + 16 + 15$) respectively. If we apply propagation model ITU-R P.1546 this equates to separation distance of 53km and 12km. The large separation distances suggest that mitigation is required to reduce the separation to more acceptable distances. LTE base stations are not to suffer from blocking. (See section 8 for mitigation and how this reduces the separation required)

³¹ Table 7.6.1.1-1 3GPP TS 36.104 v11.5.0

7.2.2 ISDB-T into LTE UE

7.2.2.1 Out of band

The LTE UE receiver is greater than 60MHz from the closest ISDB-T channel therefore interference can be considered as degradation to LTE UE noise floor. For a 5MHz channel the noise floor = -98.5dBm. To protect the noise floor from 1dB degradation the max interference level (with I/N of -6dB) is -104.5dBm (equivalent to 29dB μ V/m).

Examining the ISDB-T critical transmit masks Figure 23 at 60MHz from the centre frequency the transmit power is about 100dB down (assuming a flat response from 15MHz out to 60MHz).

In practice it is expected that the actual transmitter response will exceed this mask, as shown by the green trace in Figure 25, so attenuation well in excess of 100dB at 60MHz away is likely.

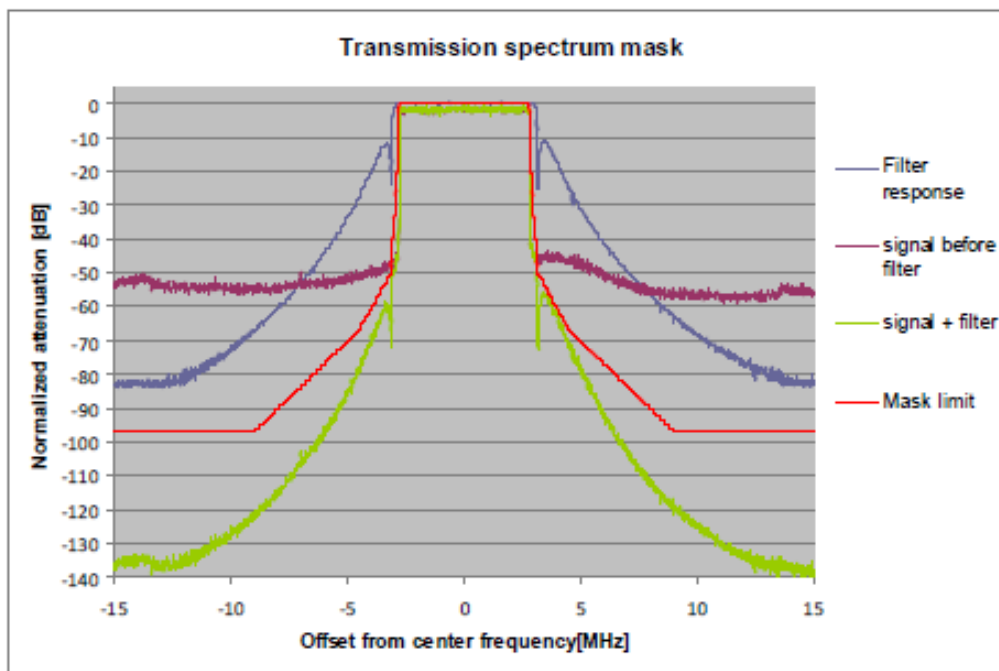

Figure 25: ISDB-T critical mask and measured signal trace.

If we just apply the critical mask limit, interference into LTE UE from ISDB-T transmitter might occur where field strengths of $(29 + 100) = 129$ dB μ V/m are exceeded.

For a 53dBW transmitter (the highest transmitter power that we have for stations in the study areas) Within a 500m metres of the transmitter there are field strengths predicted that exceed this 129 dBµV/m value. However, the predictions assume a receiver height of 10m to a rooftop antenna and the signal received at the mobile at 1.5m will be reduced. This combined with the likely improvement (of the order of 30dB) in excess of the critical mask, as shown in Figure 23, will mean that out of band interference from ISDB-T into the UE is unlikely to practically occur.

7.2.2.2 Blocking

The blocking level for the LTE UE with frequency separation between 60 and 85MHz is -30dBm (equivalent to 104dBµV/m) and for greater than 85MHz is -15dBm (equivalent to 119dBµV/m)

For the mobile we need to apply a height gain correction from 10m down to 1.5m. If we use the HATA model (equation 2.2.1.3) and assume an urban environment the value is 21dB. This means that the mobile will be blocked for field strengths of 125dBµV/m or 140dBµV/m. The diagram below shows the TV broadcast transmitters (blue squares) in Sao Paulo with areas where blocking may occur shown in red. These areas have a maximum radius of about 200m and are in practice likely to be further reduced when including the effects of the vertical radiation patterns where the mobile is likely to be in a side lobe of the transmitter. The likelihood of blocking for the mobile is considered low.



Figure 26: Potential blocking areas for Sao Paulo shown in red

7.3 ANALOGUE TV INTERFERENCE

7.3.1 LTE interference with analogue TV

The interference scenario considers the LTE base station and the mobile interfering with the domestic TV receiver.

The coupling loss computation shows the following minimum separation distances based on JTG56 model (see Appendix B for details):

TV channel offset number	0	1	2	3	4	5	6	7	8	9
Downlink separation (km)	32.2	3.0	1.3	1.3	1.2	1.2	1.1	5.3	5.0	1.2
Uplink separation (km)	1.1	0.10	0.08	0.08	0.05	0.05	0.02	0.08	0.05	0.05

10	11	12	13	14	15	16	17	18	19
1.2	1.2	1.2	1.2	5.3	6.0	1.2	1.2	0.6	0.6
0.05	0.05	0.05	0.05	0.08	0.09	0.05	0.05	0.02	0.02

Table 12: Minimum separation distance

The worst-case link is the downlink, and, for co-channel operation, the base station should be at least 32.2 km away from the domestic receiver at the edges of the broadcast footprint. This drops to 3 km in the upper adjacent channel, and of the order 6km for the intermediate/oscillator and image channels. Otherwise there should be at least 1.2 km separation. In the case of the mobile, the distances are much reduced due to the lower emissions. Co-channel operation in the downlink requires 1.1 km separation, and this drops rapidly in the first three adjacent channels to something of the order 100 m. Thereafter, the separation distance is generally of the order 50 m and drops to 10m at its lowest, although here blocking effects may dominate, as a -20dBm overload threshold corresponds to a free-space-loss separation distance of 20m. Power control at the base station is likely to only further improve the situation.

In the case of base station interference, the minimum coupling loss would coincide with aligned antennas. Reality is that the domestic antenna may not be pointing at the LTE base station, affording up to 16dB of discrimination³², and furthermore, the base station antenna is likely to be down-tilted typically offering suppression to the horizon. A typical high gain sectored antenna for LTE 700 is Kathrein's 80010736V01, which can be down-tilted to offer 3dB or more suppression to the horizon. It is also a dual polarisation antenna, so the power coupled to the domestic antenna is reduced by a further 3dB. Therefore the conclusion is that the minimum coupling loss can be improved of the order 20dB if the specific geometry of the interference case is known which would greatly reduce the minimum separation distances required.

7.3.2 Analogue TV interference with LTE

The interference scenario considers the Analogue TV transmitter interfering with the LTE base station and mobile.

Figure 27 shows the minimum separation distances between the analogue TV transmitter and the LTE BS for each of the transmitter power classes based on JTG56 model (see Appendix B for details):

³² ITU Recommendation ITU-R BT.419-3

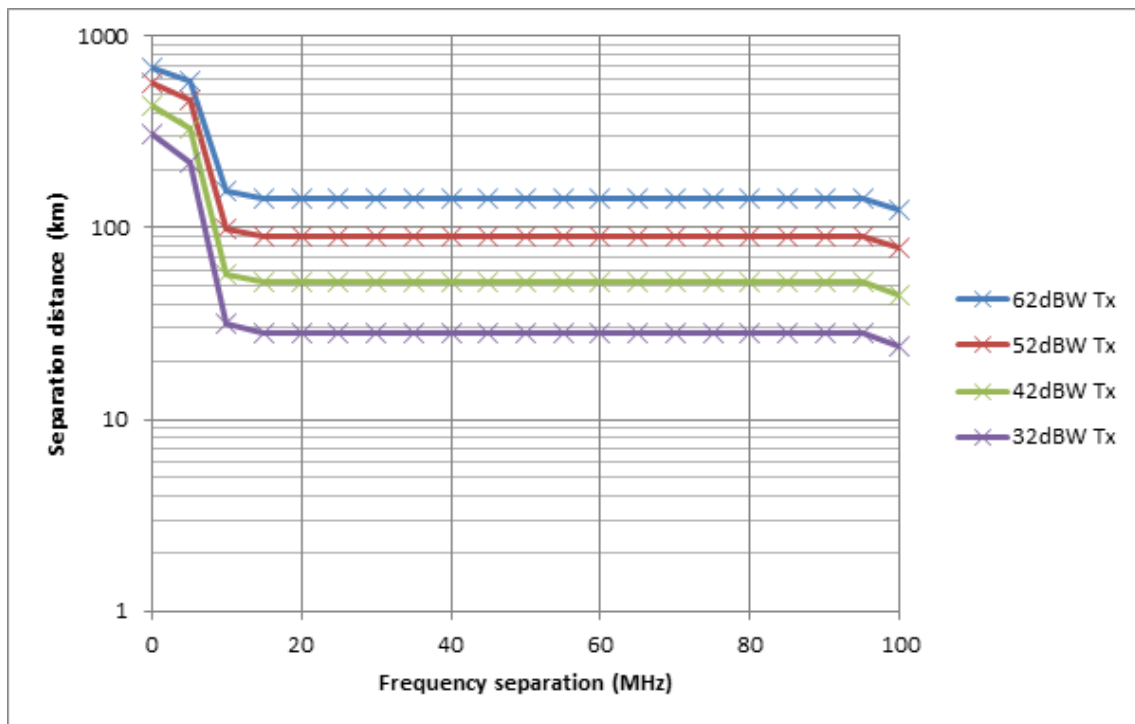

Figure 27: Minimum separation distances analogue TV and LTE BS

The separation distances are high and suggest that mitigation is required. (See section 8 for mitigation and how this reduces the separation required)

For the interference into the LTE mobile the minimum separation distances are shown below in Figure 28. Looking at Figure 28 if the systems are spectrally close, within say 10MHz, the separation distances required are quite high and would suggest that operation of high power analogue transmitter within an adjacent area would be problematic for LTE. As the frequency separation increases the distance drops and plateaus beyond 20MHz. It is anticipated that the receiver selectivity would exceed the conformance mask and so in practice the distances would continue to drop beyond 20MHz.

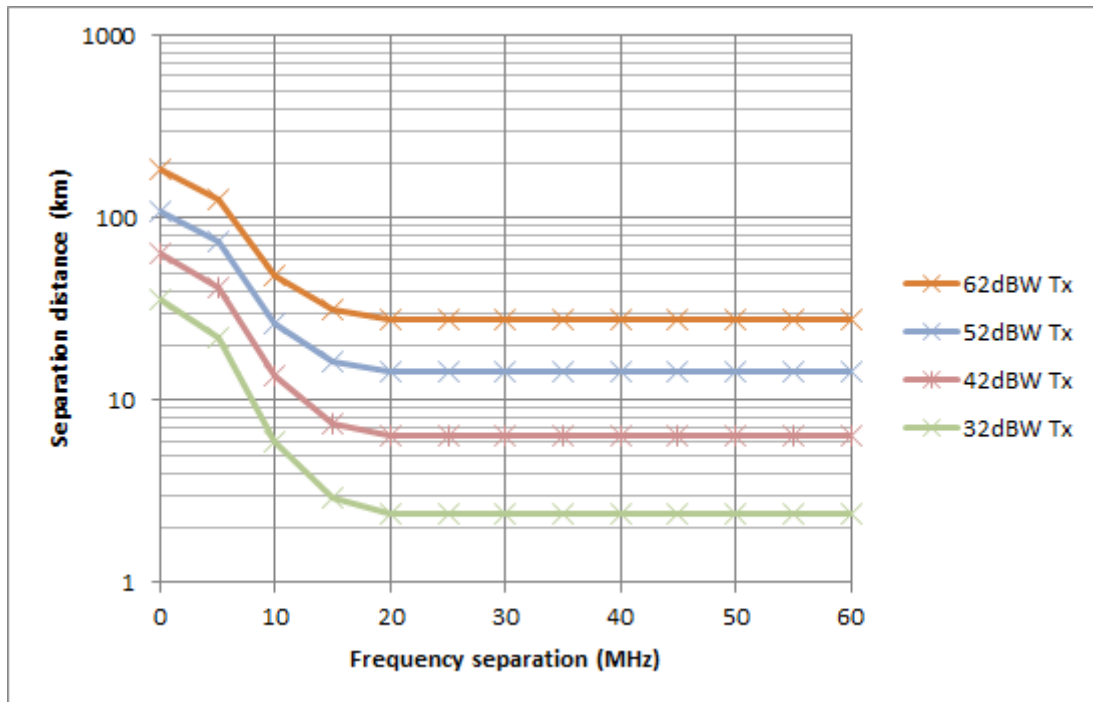

Figure 28: Minimum separation distances analogue TV and LTE UE

As for the ISDB-T to LTE UE modelling when the frequency separation is greater than 60MHz the interference can be considered as degradation to LTE UE noise floor. For a 5MHz channel the noise floor = -98.5dBm. To protect the noise floor from 1dB degradation the max interference level is -104.5dBm (equivalent to 29dBµV/m). Assuming the emissions are 100dB down at greater than 60MHz (as for ISDB-T), interference into LTE UE from ISDB-T transmitter might occur where field strengths of $(29 + 100) = 129\text{dB}\mu\text{V/m}$ are exceeded.

For a 62dBW transmitter (the highest transmitter power class for analogue TV) within 2km of the transmitter there are field strengths predicted that exceed this 129dBµV/m value. However, the predictions assume a receiver height of 10m to a rooftop antenna and if we apply a height gain correction (about 17dB based on model 1546) for a mobile at 1.5m the distance drops to a few hundred metres. In practice this is likely to be further reduced when including the effects of the vertical radiation patterns where the mobile is likely to be in a side lobe of the transmitter antenna. .

Applying any mitigation on the mobile is not considered as viable so sufficient geographic and/or frequency separation is required to prevent interference experienced by the LTE UE from analogue TV.

7.4 RESULTS SUMMARY

The following tables give a summary of the results for each of the different scenarios. The probability of interference has been categorised into either: high, medium or low.

LTE into ISDB-T

	Probability of interference	
	Out of band emissions (modelling tool approach)	Blocking (modelling tool approach)
LTE BS (30m antenna) into ISDB-T (10m fixed rooftop antenna)	Medium	Low
LTE UE (1.5m) into ISDB-T (10m fixed rooftop antenna)	Low	Low

The population interfered (LTE BS into ISDB-T) is relatively low with typically less than 50,000 for Sao Paulo and less than 10,000 for Brasilia and Campinas for out of band interference.

For LTE UE into ISDB-T the separation distances required are typically below 50m.

ISDB-T into LTE

	Probability of interference	
	Out of band emissions (MCL approach)	Blocking (MCL approach)
ISDB-T (150m antenna) into LTE BS (30m antenna)	High	High
ISDB-T (150m antenna) into LTE UE (1.5m antenna)	Low	Low

For ISDB-T into LTE BS the separation distances required are typically greater than 10km.

LTE into Analogue TV

	Probability of interference
	Out of band emissions (MCL approach)
LTE BS (30m antenna) into ATV (10 fixed rooftop antenna)	Medium
LTE UE (1.5m antenna) into ATV (10m fixed rooftop antenna)	Low

For LTE base station into analogue TV the separation distance required is typically a few kilometres. For the uplink the separation distance required is generally less than 100m.

Analogue TV into LTE

	Probability of interference
	Out of band emissions (MCL approach)
ATV (150m antenna) into LTE BS (30m antenna)	High
ATV (150m antenna) into LTE UE (1.5m antenna)	Medium

For analogue TV into LTE base station the separation distance required is greater than 10km. For the LTE mobile the separation distance required is of the order of 10km

8 MITIGATION

The results in the previous summary section, suggest that for some of the cases considered there is a likelihood of interference. This section discusses different mitigation options to help reduce the potential interference.

Essentially the mitigation falls into two main categories; mitigation to reduce out of band interference and mitigation to reduce interference by blocking. The main potential mitigations options are summarised below

Out of Band	Blocking
Emission Filter	Receiver filter
Better Receiver antenna	Better Receiver antenna
Lower transmitter power	Lower transmitter power

The mitigation options are discussed below.

8.1 LIMIT EMISSION POWER IN TOP BROADCAST CHANNELS

Limiting the emission power by appropriate planning so as to avoid high power broadcast stations in the top TV channels (48-51) will help to reduce the out of band and particularly the blocking interference experienced by the LTE base station. Analysing the post dividend plan and taking the 3 study areas as example the table below shows how the EIRP for the top 4 TV channels. The maximum EIRP is 83dBm in the study areas so in all cases the power in the top 4 channel is below this and significantly so in many cases.

Channel number	EIRP (dBm)		
	Sao Paulo	Brasilia	Campinas
51	43	69	-
50	49	49	-
49	61	73	55
48	66	64	48

Table 13: Transmitter power for top TV channels

The reduced emission in the channels immediately adjacent to the LTE BS receiver band has a significant benefit and when combined with some of the other mitigations discussed will reduce separation distance required.

So it would appear that the post dividend plan has avoided high power transmissions in the upper TV channels for the three sample areas and this approach should continue for remaining areas as they are re-planned. This mitigation is effective and cheap but there is a limit to its use whilst still being able to provide the required service area for the transmitters.

8.2 FILTERING AT THE LTE BASE STATION

The separation distances required to prevent blocking interference are about 40km. To reduce this additional attenuation is required. One method to achieve is to apply a filter at the LTE base station to reduce the large blocking signal.

Document 6A/235E³³ has 3 LTE base station filters. The characteristics of these filters are shown in Figure 29.

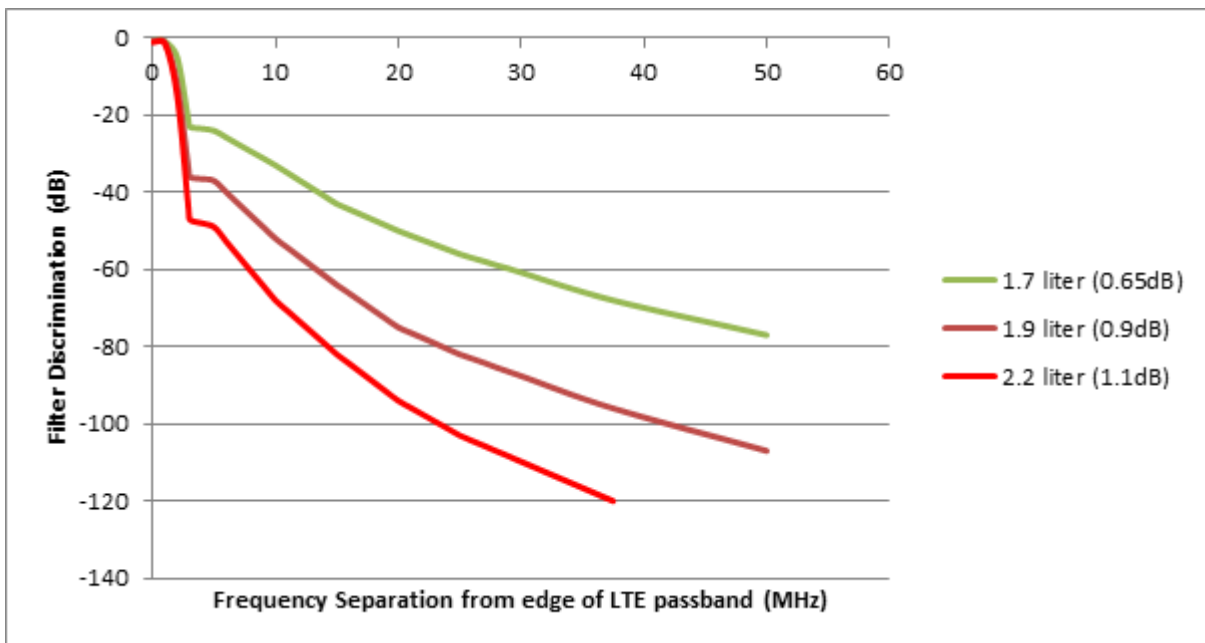

Figure 29: LTE base station filter characteristics

³³ Working party 6A Document 6A/235-E- proposed modifications to report ITU-R BT.2247-1. Study on interference between ISDB-T and IMT in the 700 MHz band.

The frequency separation between the centre of the ISDB-T transmitter and the LTE receiver channel edge is 8MHz. If we look at Figure 29 at 8MHz (assuming the centre represents an average discrimination figure across the channel width) from the edge of the LTE passband the three filters provide 30dB, 46dB, and 60dB of attenuation respectively. If we apply this to the blocking results in section 7.2.1.2 this reduces the required separation distances for channel 51 to 10.5km, 3.1km and 0.9km respectively depending on which filter is applied. How much attenuation the filter needs to provide may also depend on what other mitigation techniques have been implemented. For example if the emission power of the ISDB-T transmitter is below the 53dBW (83dBm) assumed for the modelling, and it is greater than 10dB down in most cases, there is an additional isolation contribution which a filter would not need to provide. It is not the intention here to prescribe an exact filter specification but it seems clear that a filter on the LTE base station is required, to provide some attenuation and help reduce the separation distances down to more practical levels below 1km.

Additionally by applying a filter to the LTE base station this will have a benefit on the selectivity of the receiver. If we apply the 2.2 liter filter mentioned above the improvement is shown below.

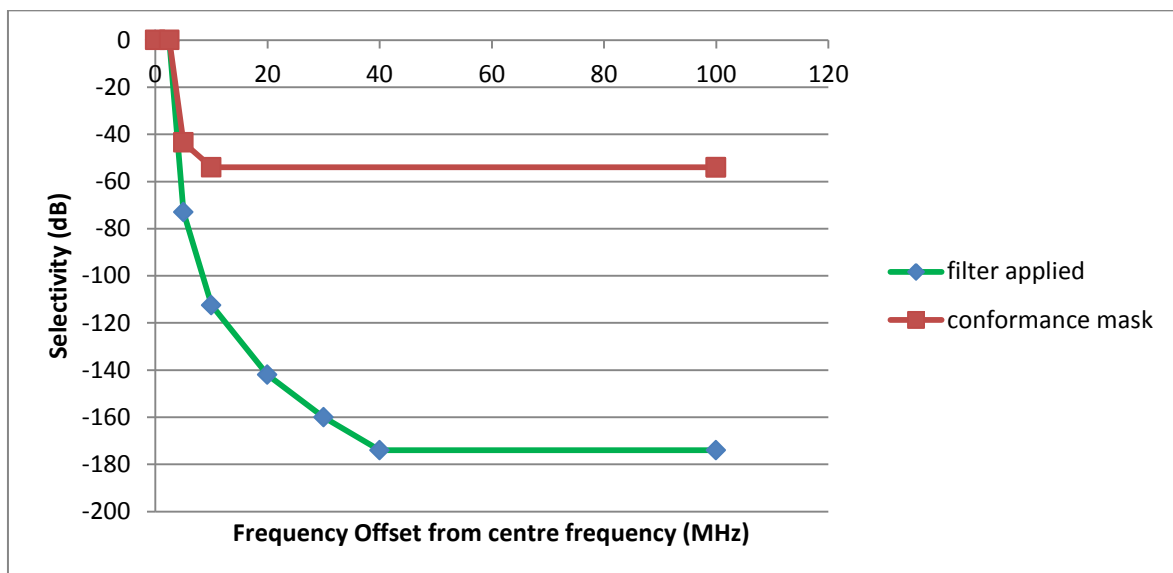

Figure 30: LTE receiver selectivity

If we use this improved selectivity and combine it with the expected emission mask (the green trace on Figure 25) having applied a filter to the ISDB-T transmitter we can re-plot the separation distances required.

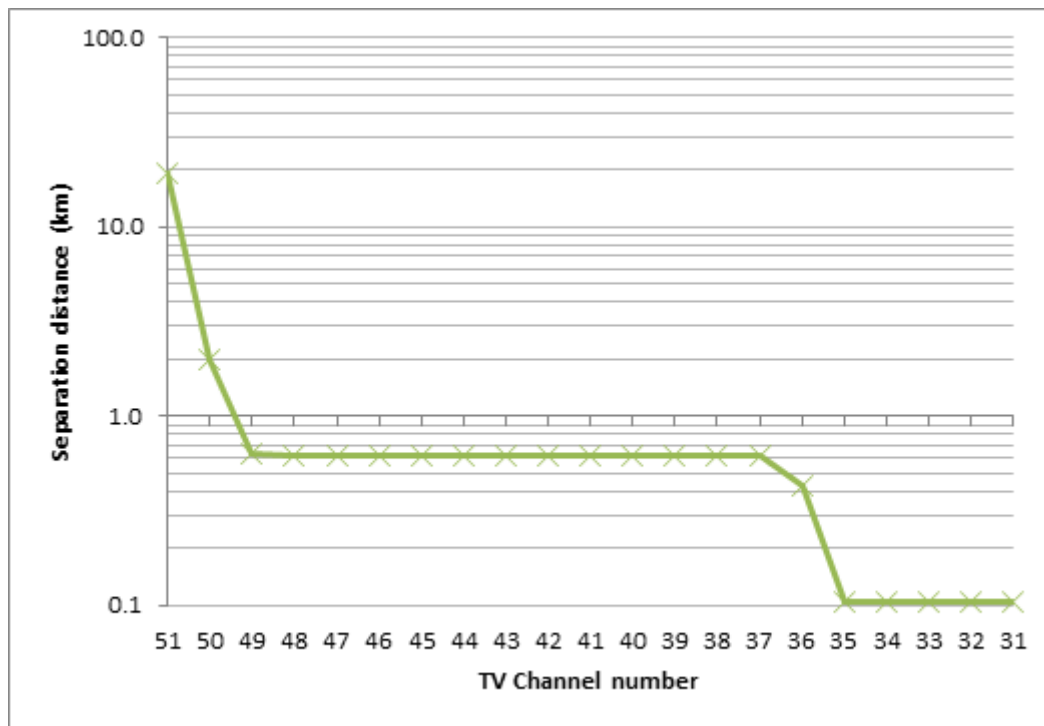

Figure 31: Separation distance for ISDB-T into LTE BS with filters applied

The separation distances outside of the top 2 TV channel have reduced to about 600m. If we consider the actual transmit powers as shown in Table 13 the power is significantly lower than the maximum EIRP of 83dBm. For Sao Paulo the separation distances required for channel 51 and 50 using the actual powers are less than 1km. For Brasilia the separation distances are approximately 8km for Channel 51 and less than 1km for channel 50 so the situation will not be as pessimistic as Figure 31 suggests.

Another factor to consider is the geometry of the situation where there is in most cases a significant difference in the height of the broadcast antenna and the cellular antenna. Furthermore, the base station antenna is likely to be down-tilted typically offering suppression to the horizon. A typical high gain sectored antenna for LTE 700 is Kathrein’s 80010736V01, which can be down-tilted to offer 3dB or more suppression to the horizon. Therefore, the unwanted signal will be suppressed in excess of 3dB which will help to further reduce the separation distances shown above.

If we apply the same filter on the LTE BS, with improved selectivity, the resulting separation distances between analogue TV and LTE BS are shown below in Figure 32

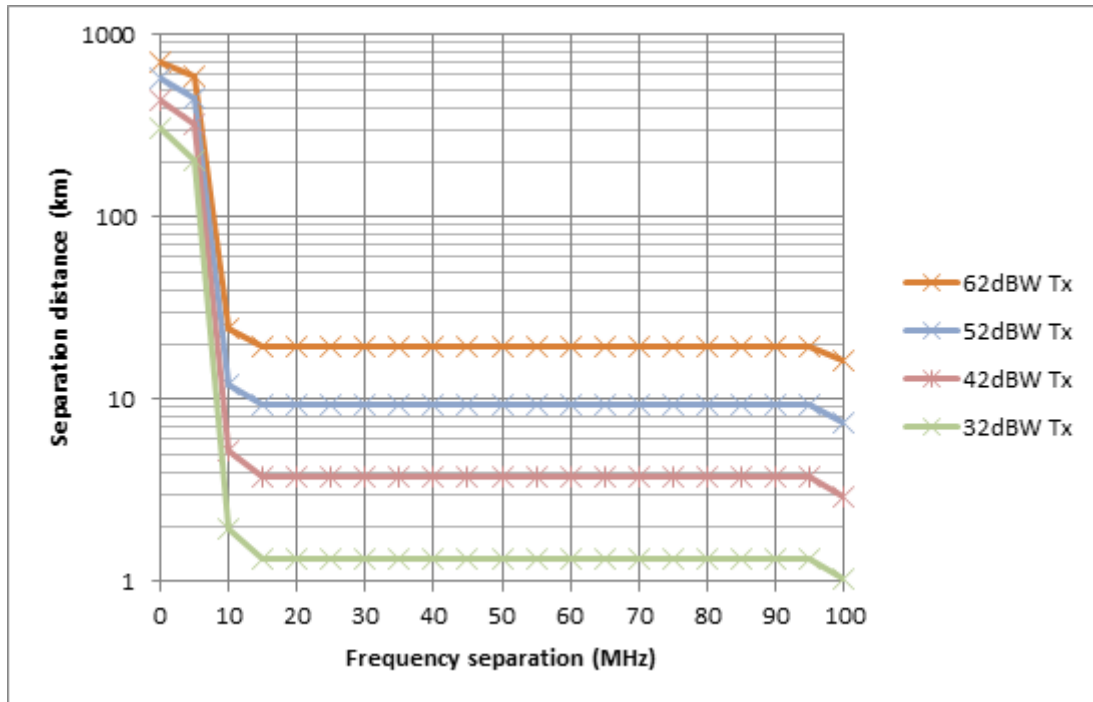

Figure 32: Separation distances for analogue TV into LTE BS with filter

Again as mentioned above an additional minimum of 3dB suppression is likely due to the downtilt of the LTE base station antenna and this will help to reduce the separation distances further. It is anticipated that LTE will not be deployed in the same area as existing analogue TV and in most cases with careful planning it should be possible to ensure sufficient isolation (by a combination of frequency and physical separation) between the analogue TV and LTE system during the transition period when analogue TV is still operational.

Filtering on the LTE base station is an effective mitigation technique but there is a significant cost if filters are applied to all the base stations.

8.3 REDUCE OUT OF BAND LTE BASE STATION POWER SPECTRA

The modelling showed there are some areas of potential interference caused by the LTE BS on ISDB-T receivers. One way to reduce this potential interference is to reduce the out of band emission of the LTE BS. If we take Sao Paulo as an example and examine the top 3 TV channels, which suffer the most potential interference, we can determine how much additional attenuation is required to eliminate the interference.

TV channel number	Population interfered			
	30dB attenuation	20dB attenuation	10dB attenuation	0dB attenuation
51	0	21	1,752	52,794
50	0	30	363	28,042
49	0	0	76	8,593

Table 14: Population interfered with additional attenuation applied

The table shows that 10dB of attenuation significantly reduces the population interfered. 20dB will leave only a small number while 30dB of attenuation would prevent any population being interfered.

The solid red line shows the LTE spectral mask and the dashed red line shows the emission level required to reduce the interference. Power control on the base station will reduce the emissions giving a benefit. However, it may still be necessary to apply a filter on the LTE transmitter to reduce the out of band emissions to the ISDB-T receivers.

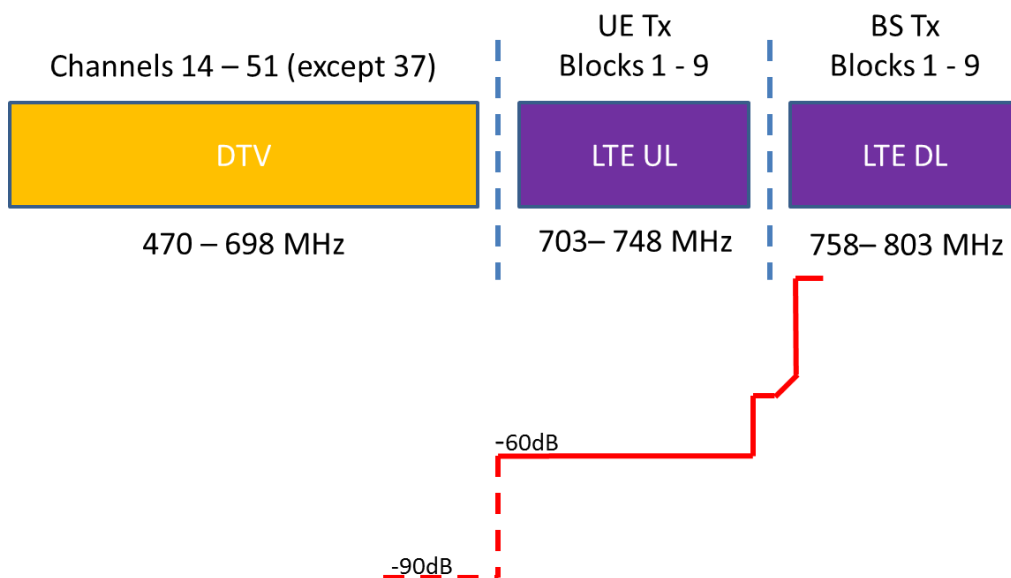

Figure 33: Attenuation for LTE power spectra

8.4 AD-HOC FILTERS AT DOMESTIC ISDB-T RECEIVERS TO REDUCE BLOCKING INTERFERENCE FROM LTE.

Although the modelling indicated that blocking is not the limiting case for interference to the ISDB-T receiver they may be some problems encountered, particularly if the ISDB-T receiver is of poor quality. Mast head amplifiers (often referred to as boosters), although not specifically covered in this study, are also likely to be more problematic. Document 6A/235E³⁴ suggests that using low noise amplifiers (LNA) will result in at least a 4dB degradation compared with not using them at the domestic antenna. So, in cases where blocking of the ISDB-T receiver is a problem an in-line filter at the ISDB-T receiver should help to reduce any blocking problems. Typically these are low-pass filter types. The frequency separation between the LTE base station and the ISDB-T receiver is more than 60MHz and this should allow sufficient frequency separation for a suitable low cost filter to attenuate the unwanted signal. However the frequency separation between the LTE UE transmit and ISDB-T is only 10MHz so it will not be possible to provide sufficient filtering to the UE frequency band. Instead protection from the UE interference will simply be down to the inherent protection offered by the receiver but the lower power emission from the UE means it is unlikely to be a problem anyway.

Filters are likely to be required on only on a case by case basis and should be a relatively cheap and effective way to combat blocking issues from the LTE base station.

8.5 SPECIFY IMPROVED ANTENNA AT THE DOMESTIC RECEIVER

The antenna used in this study is based on the recommendation ITU-R BT 419-3 antenna measurements, which can be considered as a mask representing the minimum performance. Real antenna patterns may have a better directional gain or better side lobe suppression. Report ITU-R BT.2138³⁵ contains the results of various measured patterns for different types of antennas and compares them with the BT. 419 specification.

The report describes a number of different types, predominately comprising conventional Yagi antennas and phased arrays on grid reflectors. Yagi antennas have the property of high gain, and are often used towards the edge of coverage areas, but these antennas often exhibit poor side lobe performance. Phased array antennas have a lower gain than Yagi antennas but their advantage is a better side

³⁴ Working party 6A Document 6A/235-E- proposed modifications to report ITU-R BT.2247-1. Study on interference between ISDB-T and IMT in the 700 MHz band.

³⁵ BT.2138-0 (2008) Radiation pattern characteristics of UHF television receiving antennas

lobe performance so that interfering radiation coming off beam is often well attenuated. Antenna model 3 is a phased array antenna with 4 elements. This antenna was chosen as a possible improvement to the BT 419 mask, in terms of the reduced sidelobes that may attenuate interference better. The following figure shows a co-polar mask derived from the measurements for model 3 in ITU-R BT.2138.

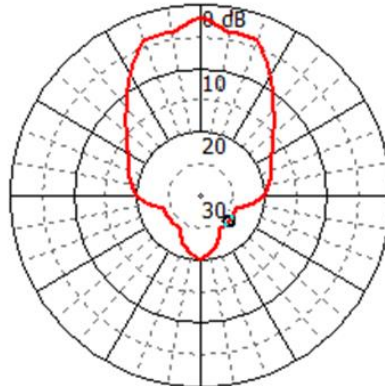

Figure 34: Horizontal pattern of alternative phased array antenna

Using an antenna with better side lobe attenuation can help to reduce the affected population. However this comes at the expense of poorer antenna gain, so these antennas should only be used in area with stronger signals, from the broadcast system, such as in urban areas. The assumption is that the performance of these antennas is achievable in a real installation and that even with the effects of reflections from clutter, that the improved side lobe suppression is achievable.

This mitigation technique is relatively cheap but will only be effective in specific situations where the interference is marginal.

8.6 USE OF ORTHOGONAL POLARISATION FOR LTE BS

The ISDB-T emissions are mostly horizontal polarised. Using a vertical polarised LTE signal will increase the antennas discrimination to the horizontally polarised broadcast antennas, which will make the receiver less vulnerable to the interfering signal.

The original calculation considered a 3dB polarisation discrimination for dual slant antennas. Using orthogonal polarisation would give significant extra discrimination (approx. 16dB). However for MIMO implementation spaced antennas would be needed and the additional cost and complexity for the mobile operator of using vertical polarisation means this option is considered unlikely to be seriously viable.

8.7 SPECIFY THE USE OF GOOD QUALITY TV RECEIVERS

The performance of the TV receivers will vary and this may result in a situation where a poor quality receiver experiences interference while a neighbouring receiver of better quality does not. So a potential mitigation option would be to specify a minimum receiver performance that a TV receiver must meet to prevent this situation.

There is a precedent for such mitigation as Norway has mandated minimum performance specifications for their TV receivers (Nordig) and this provides some real benefits.

However, there is obviously a limit to the performance that can be expected of consumer grade receivers and if the interfering signal is sufficiently high then problems may still be encountered even if a good quality receiver is used. This would therefore require other mitigation to be implemented to address the interference at the transmission source.

A drawback of this option is that implementing it requires legislation and testing of devices, or adoption by industry groups to ensure that the minimum specification is being met. This could be costly. Any legislation would also take time to bring into force and so there will already be a significant number of existing receivers that would not meet any new standard that is introduced.

Even if the receiver performance is not mandated in some circumstances replacing a poor quality receiver with a good quality one may help to alleviate some local interference issues.

9 CONCLUSIONS AND RECOMMENDATIONS

This report looked at the coexistence primarily between LTE and ISDB-T but also considered analogue TV effects during the transition period to a post dividend plan. There were two types of interference investigated. First, interference from adjacent channels (out of band), and second the interference through blocking. This out of band assessment concentrated on the top broadcast channels (44 to 51) and the lowest LTE uplink or downlink channel block. The blocking interference analysis considered all TV channels and not just the top channels.

As a general rule the edges of the wanted service area are the most vulnerable to out of band interference and blocking is generally confined to areas in close proximity to the transmitters.

For the LTE BS interference into the ISDB-T receiver the modelling used the actual locations and transmitter details following the implementation of the post dividend plan. The LTE network base station locations were based on the existing stations for the largest existing mobile operator. This was combined with census data to quantify the population impact of any potential interference on the three study areas, namely Sao Paulo, Brasilia and Campinas. The results show that out of band interference is dominant with a potential population of about 50,000 (assuming 50% locations) affected in Sao Paulo. The actual area of interference is relatively low at 5km² but the high population density for Sao Paulo explains the population affected figure.

For Brasilia and Campinas the population affected is generally below 10,000. The potential interference areas can be reduced by applying suitable mitigation. With 10dB of additional attenuation the population affected is reduced to 2,000 from 50,000 with similar improvements for the other channels. The assessment generally follows a conservative approach with modelling at full power. Factors such as LTE base station transmit power control where the transmitted power is adjusted regarding to the receiver distance will help. As a result the interference (out of band and blocking) will be lower as less energy will be radiated by the LTE stations.

For the LTE UE interfering with ISDB-T the probability of interference from blocking and out of band emissions is low.

The results for the other scenarios show that out of band emissions is the dominant effect. The worst case predicted is for ISDB-T into the LTE BS where separation distances would need to be high to overcome potential blocking and out of band interference issues if no mitigation is applied.

It is recommended to apply a filter to the ISDB-T transmitter to achieve, and ideally exceed the critical transmission mask. It would be useful to measure the resulting ISDB-T power spectra following the implementation of a filter to be able to more accurately quantify the likely improvement over the critical mask. It is also recommended to apply a filter to the LTE base station. Both of these filters combined will help to significantly lower the probability of out of band and blocking interference.

There is obviously a significant cost of implementing these filters but they should prove to be an effective mitigation to help coexistence.

It is also recommended to adopt post dividend plans that avoid high power emissions in the upper TV channels (especially channels 48-51). This planning approach will help with coexistence as the potential interference problem is more acute where frequency separation to the lowest LTE band is small. The advantage of this mitigation is that it costs nothing to implement.

Analogue TV will gradually be switched off and there will be instances of analogue TV transmitting in areas adjacent to LTE deployment.

To avoid potential analogue TV interference caused by LTE the separation distances required are 32km (downlink) and 1km (uplink) for the co-channel case. The separation distance drops rapidly to a few kilometres (downlink) and less than 100m (uplink) for the first adjacent channel and continues to drop as frequency separation increases.

The reverse case, analogue TV interfering with LTE, is likely to require higher separation distances with more than 100km required where the frequency separation is low (<10MHz). Given that the analogue transmitters will be switched off it is not considered cost effective to apply any mitigation, such as filters, to the analogue transmitters to reduce the out of band emissions. So it is recommended to have a frequency separation of at least 20MHz between the analogue TV and the LTE receiver to help reduce the separation distances required to the order of 10km. It may also be advisable to model specific cases where there are concerns about potential interference from analogue TV as the actual power and frequency separation can be taken into account and a more definitive answer provided.

This report discussed a number of mitigation techniques and none are a panacea on their own. Each technique discussed has benefits in terms of cost versus effectiveness with some considered more viable than others.

Of the mitigation techniques considered filters will provide the most significant benefit but also likely to be the most expensive to universally apply.

Where interference is experienced by the TV receiver there are a number of possible mitigation options such as receiver filtering, improved antenna or use of a better quality receiver. These would need to be investigated on a case by case basis to try and resolve any local interference issues but would be relatively cheap to implement.

In practice a combination of the mitigation techniques is likely to be required as discussed in the report and the general conclusion is provided suitable mitigation is applied that coexistence between LTE and ISDB-T is possible.

APPENDIX A

Location correction factor

In broadcasting the minimum median equivalent field strength is typically quoted and gives the minimum required signal strength for successful operation. These field strengths are for 50% locations.

If we take a notional small area of say 100 m by 100 m, the signal received will vary due to changes in the local terrain and clutter. The minimum median equivalent field strength is for 50 % of locations. I.e. within that 100m x 100m area if we have a number of field strength measurements 50% will exceed and 50% will be below this median value. If we are interested in reception to a fixed antenna, then unlike a mobile, we have no opportunity to move our receiving antenna to a new location to overcome a local null. So simply stating the median field strength value for 50% locations may give unrealistic expectations of being able to receive a service.

To obtain the minimum median equivalent field strength needed to provide reception at a higher percentage of locations, a location correction factor C_l has to be added. In calculating the location correction factor C_l , a log-normal distribution of the received signal with location is assumed for fixed rooftop reception.

The location correction factor, C_l , (dB) can be calculated by the formula:

$$C_l = \mu * \sigma$$

Where:

μ is the log-normal distribution factor, being

- 0.00 for 50% of locations,
- 0.52 for 70% of locations,
- 1.28 for 90% of locations,
- 1.64 for 95% of locations and
- 2.33 for 99% of locations.

σ is the aggregate standard deviation of fading which is 5.5 dB for fixed rooftop reception.

Therefore if we are interested in the signal strength exceeding the minimum value for 95 % locations we need to add the location correction factor of 9 (1.6x5.5) dB.

This concept is explained further in the GE06 agreement document Annex 2 §3.4.5.1.

Location correction margin

The system protection ratios are typically defined for the median values which mean they are valid for 50% of the locations inside an area. The location correction margin is added to the system protection ratio (for 50% of locations) to give the amount (in dB) by which the wanted signal must exceed the interfering signal in order to provide protection at greater than 50% of locations. The location correction margin is related to the location correction factor, and in deriving it from the location correction factor, it is assumed that the wanted and interfering signals are both normally distributed, are un-correlated and have identical aggregate standard deviations.

The resultant standard deviation is calculated as follows

$$\sigma_{\text{res}} = \sqrt{\sigma_{\text{wanted}}^2 + \sigma_{\text{wanted}}^2}$$

$$\text{i.e., } \sigma_{\text{res}} = \sqrt{2} * (\sigma_{\text{wanted}})$$

$$\text{since } \sigma_{\text{wanted}} = \sigma_{\text{interferer}}$$

For fixed rooftop reception the aggregate standard deviation of fading, σ , is 5.5 dB which makes the resultant standard deviation, $\sigma_{\text{res}} = \sqrt{2} * 5.5 = 7.8$ dB. Therefore for 95 % locations, the location correction margin is: $7.8 \text{ dB} * 1.64 = 12.8$ dB, (where 1.64 is the log-normal distribution factor)

Location correction margin is discussed in Annex 2 §3.4.5.3 of the GE06 agreement.

APPENDIX B

For the calculation of the unwanted field strength from the mobile LTE network the propagation model JTG5-6 was used. This model is a hybrid of ITU P.1546-4³⁶ and an extended Hata model³⁷.

The Hata model was developed for land-mobile services and was derived from measurements taken in urban areas in Tokyo, Japan by Okumura. These measurements curves were later formulated by Hata. The model is valid for path lengths between 10 m to 40 km, low receiver antenna heights in clutter (1-10 m above ground) and base station antennas installed above roof-top level (10-200 m).

Whereas the ITU P.1546-4 model was derived from measurements performed for UHF/VHF broadcasting distances beyond 1 km using high power transmitter stations and fixed receiver antennas. It was later extrapolated for smaller distances down to 1 km and also low receiver antenna heights. The model is valid for path length between 1 km and 1000 km, low receiver antenna heights (1-10 m above ground) and base station antennas installed hundreds of meters above ground level.

JTG5-6 is specifically designed for base station interference into fixed or mobile DTT systems and combines both approaches to cover continuously the range from 10 m to 100 km. The model combines the following loss calculations:

- 40-100 m: free space loss,
- 100-1000 m path loss for urban area, interpolated between the values determined for 100 m based on Okumura/Hata and 1000 m based on ITU-P.1546
- greater than 1 km: ITU-R P.1546-4 model (land curves)

The figure below shows the different distances and corresponding propagation models. As the interpolation method between 100 m and 1km is not very well specified, two different approaches are shown (green and red curve). The green line applies the extended Hata model with the restriction to free space results at 100m distance and provides path losses which are definitely greater equal than free space attenuation for all distances. The red line applies to the original Hata formula results at 100 m distance. If the path loss computed with Hata is less than free space, some of the interpolated values will be less than free space attenuation. It is then recommended to restrict the path loss at 100 m to free space or values greater than the free space attenuation (green curve).

³⁶ ITU-R P.1546-4 – “Method for point-to-area predictions for terrestrial services in the frequency range 30 MHz to 3 000 MHz”, ITU 2009

³⁷ Okumura-Hata Model, Okumura, Y. a kol.: “Field Strength and its Variability in VHF and UHF Land-Mobile Radio Service”. Rev. Elec. Comm. Lab. No.9-10pp. 825 - 873, 1968. - Hata, M.: “Empirical Formula for Propagation Loss in Land Mobile Radio Services”, IEEE Trans. Vehicular Technology, VT-29, pp. 317 - 325, 1980.

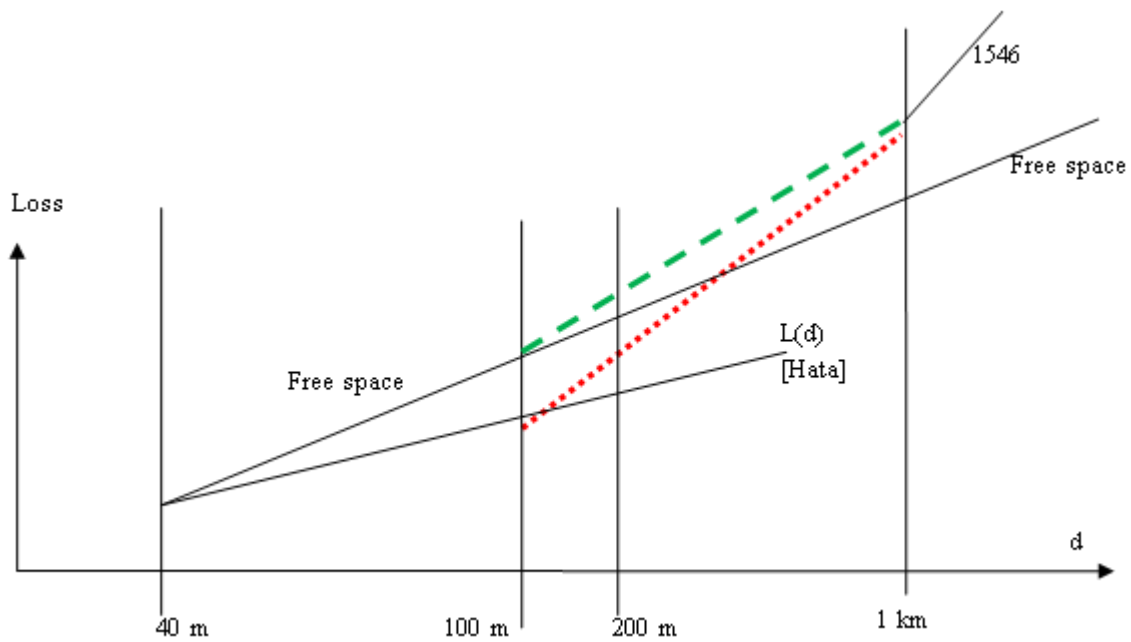

Figure 35: ITU JTG5-6 integrated propagation methods according to path length

The model is described in more detailed in the ECC CPG11 PT-D³⁸ and the ITU document 5- 6/107-E³⁹.

³⁸ ECC report CPG11-1 PT-D, "comments on JTG5-6 propagation model, Maisons-Alfort, 14-15 April 2009

³⁹ ITU JTG 5-6, Document 5-6/107-E –“ Updated Joint Task Group 5-6 propagation model” , November 2009

APPENDIX C – 95% LOCATIONS RESULTS

LTE BS interference with ISDB-T (Out of band interference)

Sao Paulo

The wanted service area for each of the TV broadcast channels is shown below. The red area corresponds to a threshold of greater than 60 dBµV/m (95% locations) and the blue area corresponds to threshold level between 51 and 60 dBµV/m. The size of the coverage areas vary mainly due to the difference in the radiated powers.

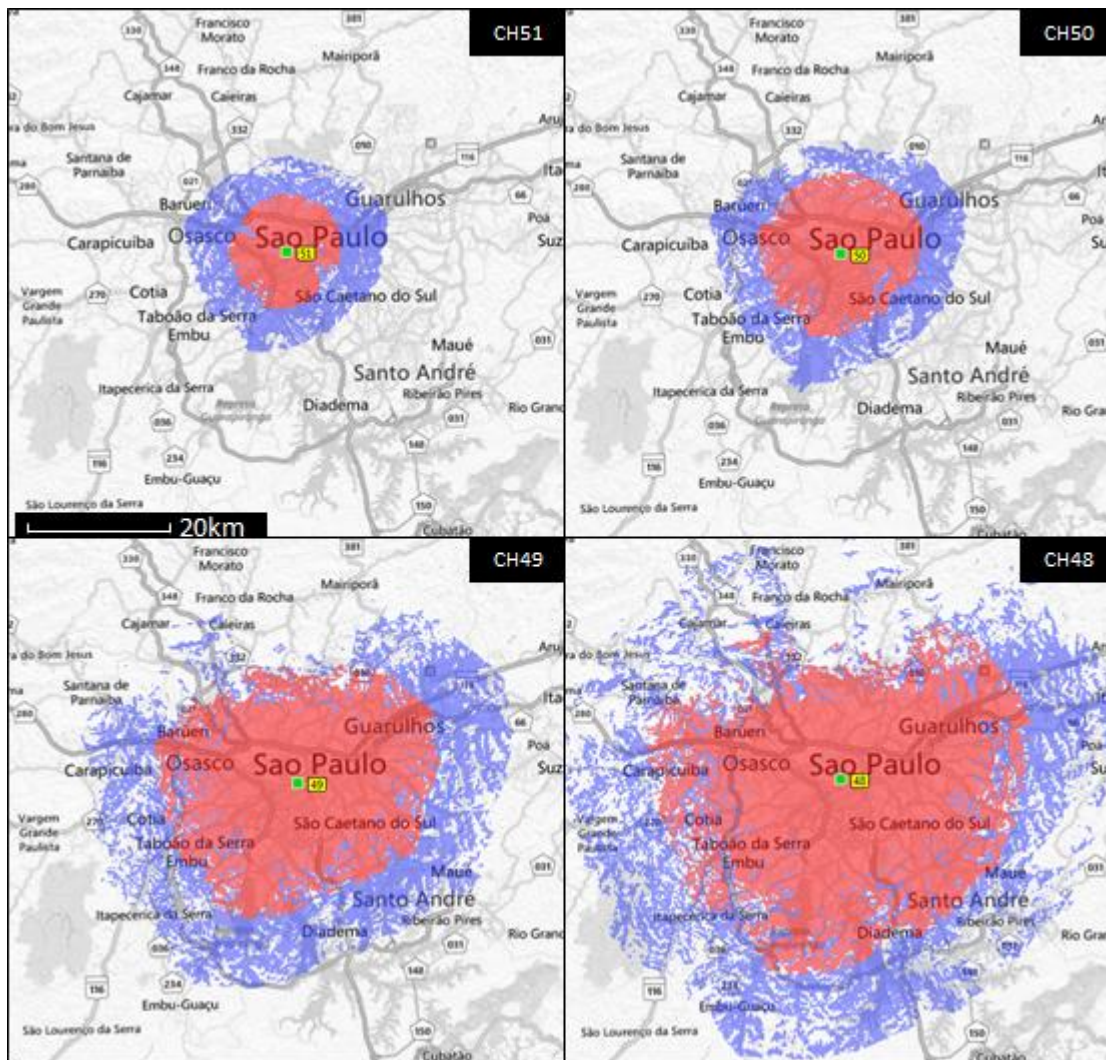

Figure 36: Sao Paulo TV coverage for channels 48 to 51

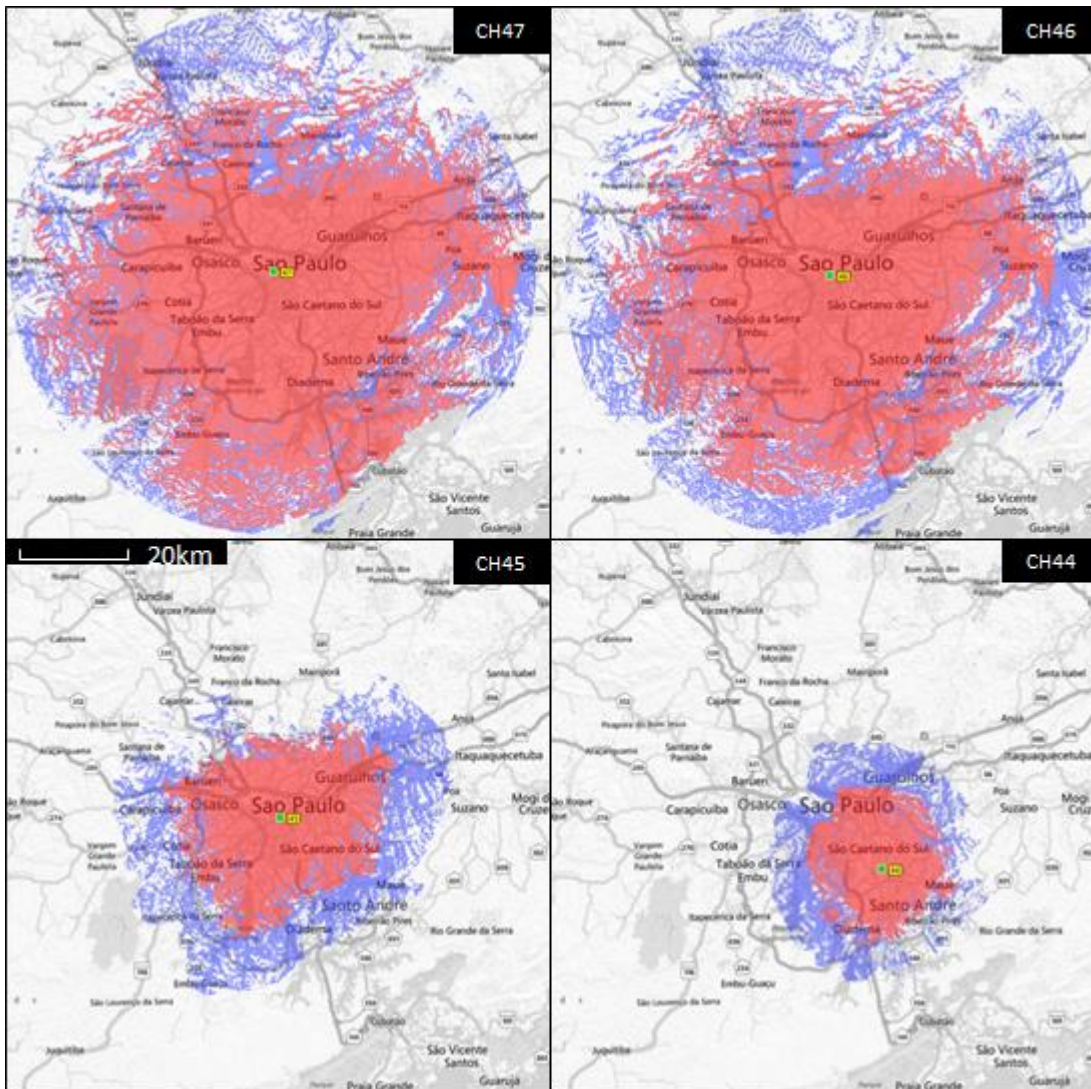

Figure 37: Sao Paulo TV coverage for channels 44 to 47

For each of the channels shown the out of band interference caused by the LTE base stations was predicted.

Table 15 shows the area that is interfered as well as the population affected.

Frequency MHz	Channel number	Separation (MHz) to FDD1#D	Urban area interfered km ²		Population in urban areas interfered		Percentage of population in urban areas interfered	
			50% locations	95% locations	50% locations	95% locations	50% locations	95% locations
695	51	60	5.2	20.7	52,794	210,926	0.1%	14.1%
689	50	66	2.3	18.1	28,042	190,207	0.4%	5.9%
683	49	72	0.7	6.5	8,593	82,903	0.1%	1.0%
677	48	78	0.2	3.8	2,288	55,269	<0.1%	0.5%
671	47	84	<0.1	0.1	66	2,636	<0.1%	<0.1%
665	46	90	<0.1	0.2	66	3,522	<0.1%	<0.1%
659	45	96	0.5	5.8	6,316	85,306	<0.1%	0.9%
653	44	102	0.0	0.0	0	0	0%	0%

Table 15: Population and area interfered for Sao Paulo

The 95% locations values are shown along with the 50% (median case based on the Anatel resolution 398/2005) for comparison. 95% locations are considered more usual of a network deployment for a wanted service area. The 95% locations include a location correction factors to uplift from the median case. (see Appendix A for further details).

The 95% locations results have a greater area and population interfered in comparison with the 50% locations case. This is as one might expect as the protection ratios for 95% locations are lower than the median case as a location correction margin (see Appendix B) is added to protect 95% locations.

Brasilia

The wanted service area for each of the TV broadcast channels is shown below. The red area corresponds to a threshold of greater than 60 dB μ V/m (95% locations) and the blue area corresponds to threshold level between 51 and 60dB μ V/m. The size of the coverage areas vary mainly due to the difference in the radiated powers.

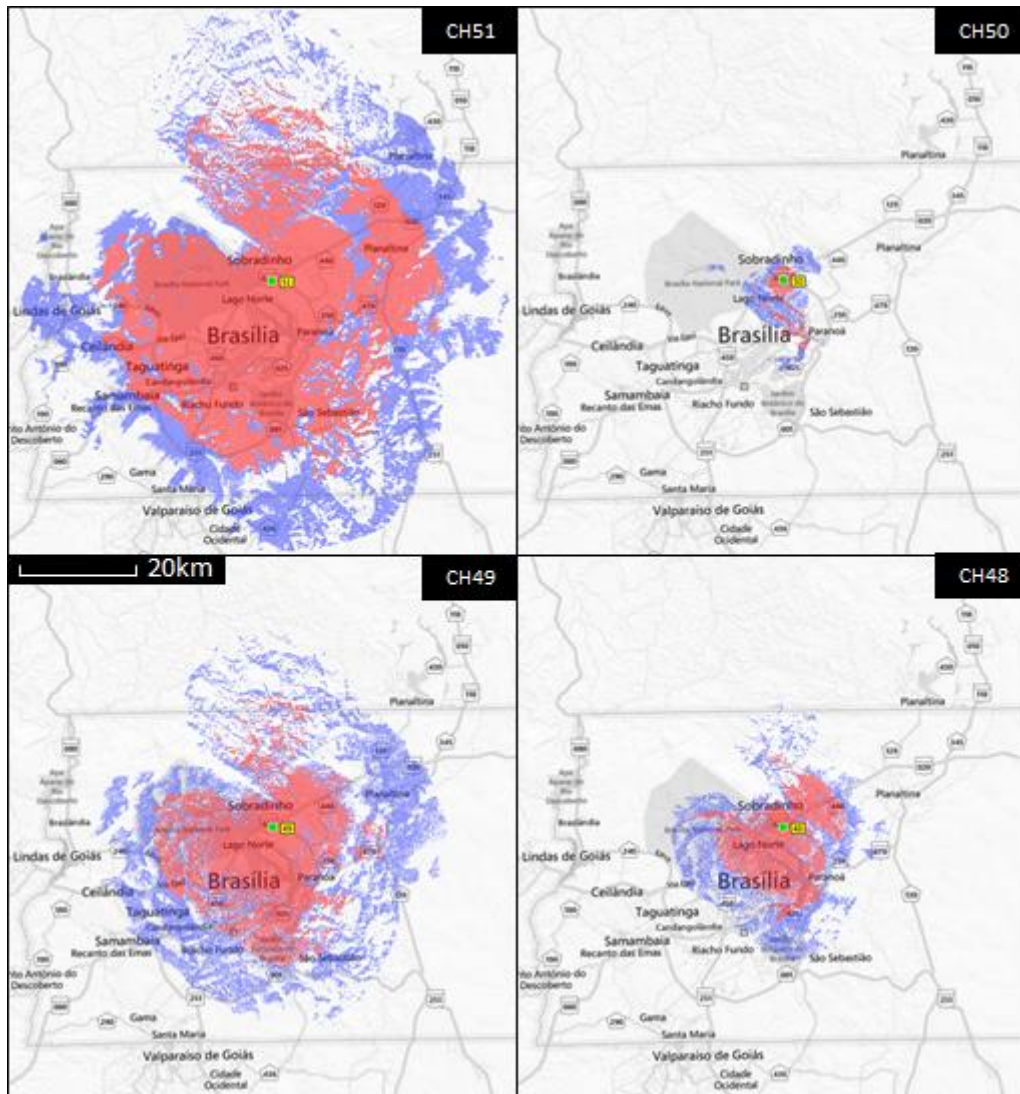

Figure 38: Brasilia TV coverage for channels 48 to 51

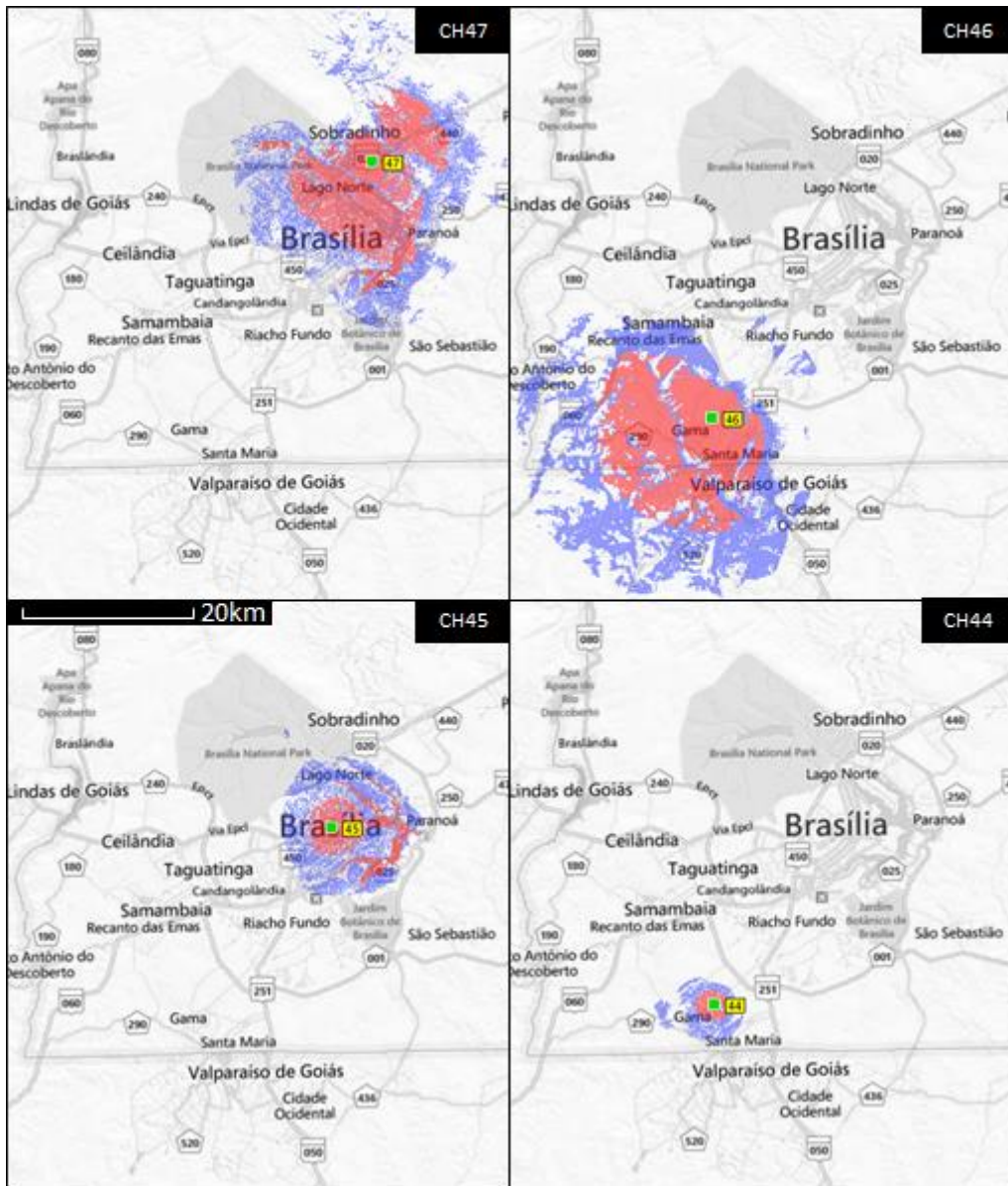

Figure 39: Brasilia TV coverage for channels 44 to 47

Table 16 shows for Brasilia the areas that interference is predicted as well as the population affected

Frequency MHz	Channel number	Separation (MHz) to FDD1#D	Urban area interfered km ²		Population in urban areas interfered		Percentage of population in urban areas interfered	
			50% locations	95% locations	50% locations	95% locations	50% locations	95% locations
695	51	60	0.7	4.5	4,571	38,156	0.2%	2.3%
689	50	66	0.8	0.0	6,949	248	5.3%	2.6%
683	49	72	1.7	3.8	14,395	18,518	1.1%	3.3%
677	48	78	1.1	3.3	4,302	10,648	0.9%	4.1%
671	47	84	1.1	2.9	5,044	13,960	1.2%	6.1%
665	46	90	0.2	1.2	1,278	9,837	0.2%	3.3%
659	45	96	1.3	3.6	3,276	16,049	1.3%	15.6%
653	44	102	0.0	0.0	187	18	0.2%	0.1%

Table 16: Population and area interfered for Brasilia

The 95% locations values are shown along with the 50% (median case based on the Anatel resolution 398/2005) for comparison. 95% locations are considered more usual of a network deployment for a wanted service area. The 95% locations include a location correction factors to uplift from the median case. (see Appendix A for further details).

For all channels except channel 50 and 44 the interference is higher for 95% locations than for 50% locations. To explain why let us look at channel 50.

In Figure 40 below you can see coverage for channel 50. The red areas are where the field strength exceeds 60dBµV/m, while the blue areas the field strength is between 60 and 51dBµV/m. In the area circled there is some interference close to the LTE base stations (the black squares) for the median (50% locations case). However the coverage for this area is below the 60dBµV/m threshold so is not considered as an area for wanted coverage for the 95% locations. As a result the interference close to the LTE base stations in the circle is not included for the 95% locations case. So because of the small coverage area and location of the base stations the interference area is actually larger for the 50% case rather than the 95% case. The same thing happens for channel 44.

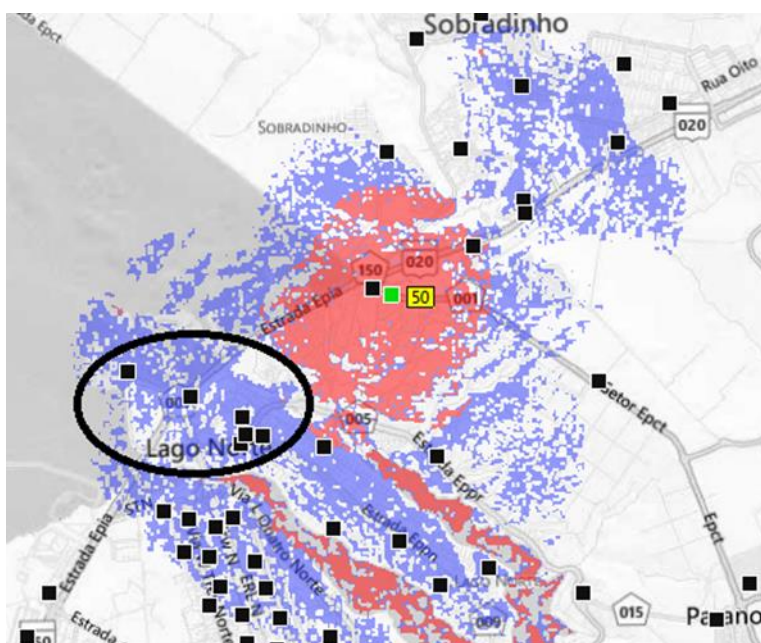

Figure 40: TV channel 50 with LTE base station locations

In all the other cases although the wanted coverage area is smaller for the 95% locations compared with the 50% locations this is offset by the lower protection ratios (about 13db) that apply when protecting 95% locations and this results in larger interfered areas for the 95% case compared with the 50% case.

Campinas

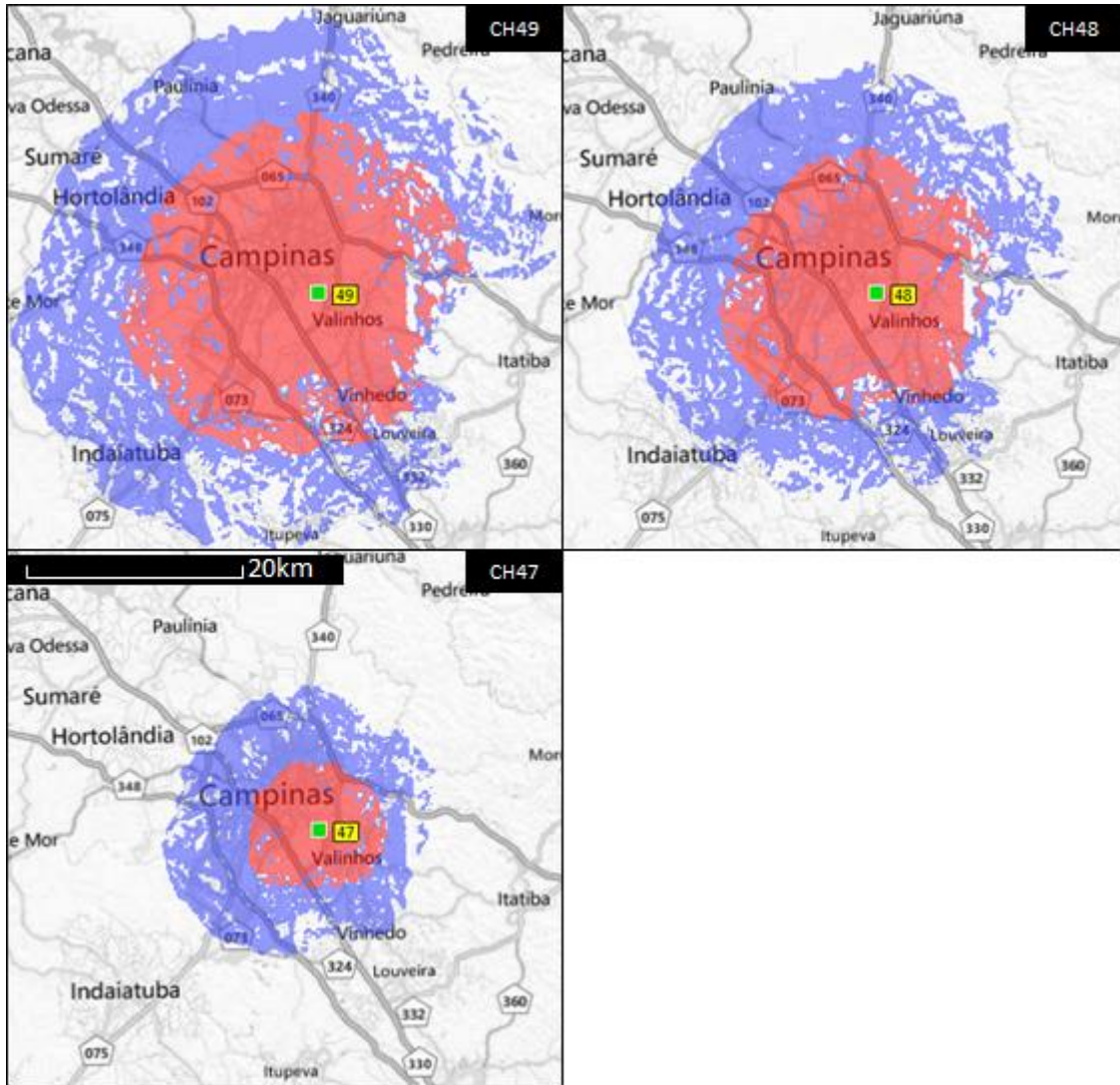

Figure 41: Campinas TV coverage for channels 47 to 49

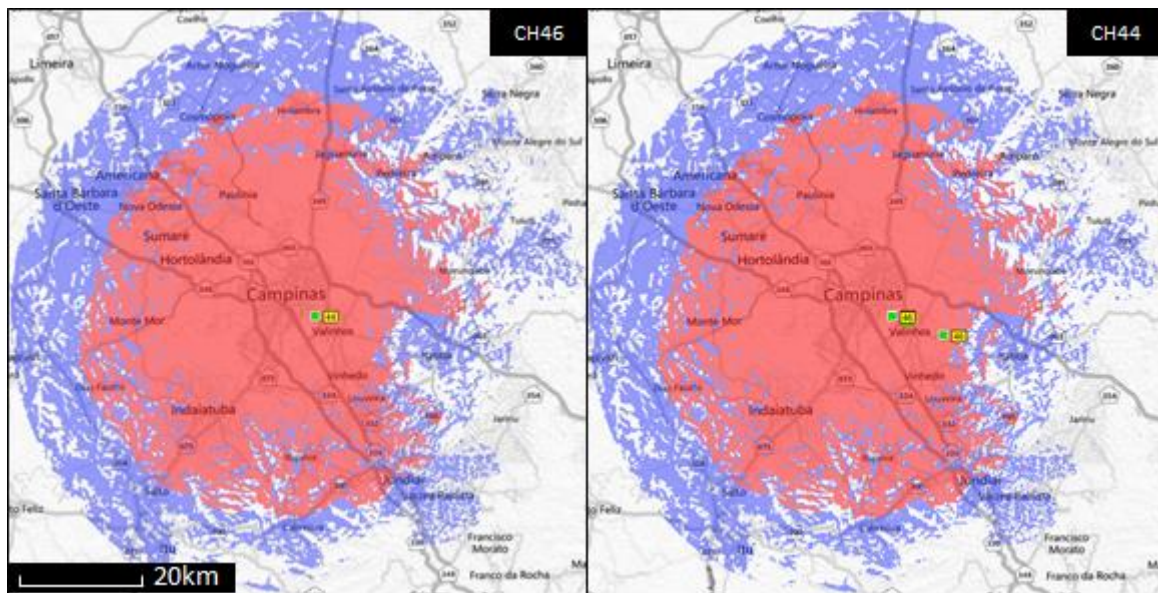

Figure 42: Campinas TV coverage for channels 44 and 46

Table 17 shows the area that is interfered as well as the population affected.

Frequency MHz	Channel number	Separation (MHz) to FDD1#D	Urban area interfered km ²		Population in urban areas interfered		Percentage of population in urban areas interfered	
			50% locations	95% locations	50% locations	95% locations	50% locations	95% locations
695	51	60	-	-	-	-	-	-
689	50	66	-	-	-	-	-	-
683	49	72	<0.1	1.6	39	3,960	0.0%	0.3%
677	48	78	0.1	2.8	307	7,556	0.0%	0.8%
671	47	84	1.0	3.0	2,520	16,833	0.3%	4.4%
665	46	90	<0.1	0.1	1	17	<0.1%	0.1%
659	45	96	-	-	-	-	-	-
653	44	102	0	<0.1	0	7	0%	<0.1%

Table 17: Population and area interfered for Campinas

The 95% locations values are shown along with the 50% (median case based on the Anatel resolution 398/2005) for comparison. 95% locations are considered more usual of a network deployment for a wanted service area. The 95% locations include

a location correction factor to uplift from the median case. (see Appendix A for further details).

The 95% locations results have a greater area and population interfered in comparison with the 50% locations case. This is as one might expect as the protection ratios for 95% locations are lower than the median case as a location correction margin (see Appendix B) is added to protect 95% locations.

.