



## Steering of Roaming Implementation Guidelines

Version 5.0

04 May 2020

*This is a Non-binding Permanent Reference Document of the GSMA*

---

### **Security Classification: Confidential - Full, Rapporteur, Associate and Affiliate Members**

Access to and distribution of this document is restricted to the persons permitted by the security classification. This document is confidential to the Association and is subject to copyright protection. This document is to be used only for the purposes for which it has been supplied and information contained in it must not be disclosed or in any other way made available, in whole or in part, to persons other than those permitted under the security classification without the prior written approval of the Association.

### **Copyright Notice**

Copyright © 2020 GSM Association

### **Disclaimer**

The GSM Association ("Association") makes no representation, warranty or undertaking (express or implied) with respect to and does not accept any responsibility for, and hereby disclaims liability for the accuracy or completeness or timeliness of the information contained in this document. The information contained in this document may be subject to change without prior notice.

### **Antitrust Notice**

The information contain herein is in full compliance with the GSM Association's antitrust compliance policy.

## Table of Contents

	<b>Introduction</b>	<b>4</b>
	Overview	4
	Scope	4
1	Definitions	4
1.1	Document Cross-References	5
1.2	<b>Steering of Roaming Cooperation Principles</b>	<b>6</b>
1.3	Transparency	6
1.4	Rules for cooperation between networks	6
2	2.1 In case of transparency	6
	2.2 In case of non transparency	7
	2.2.1 Error Codes	8
	2.2.2 <b>SS7 based methods technical description</b>	<b>8</b>
	2.2.3 SS7 Node Based redirection	8
3	3.1 Routing Rules deletion	10
	3.2 HLR & VLR Blocking	12
	3.3 <b>Customer Experience Assessment</b>	<b>13</b>
4	4.1 SS7 based redirection	13
5	<b>SS7 steering implementation Guidelines</b>	<b>14</b>
	5.1 Protocol Level	15
	5.2 Procedure	15
	5.3 Map error cause mapping between network and terminal device	15
	5.4 Implementation of Error codes	17
	5.5 Management	18
	5.6 Specific SCCP Global Title	19
6	6.1 <b>Diameter steering (steering in LTE networks)</b>	<b>19</b>
	6.2 Technical description	19
	6.3 CSFB issues	22
	6.4 Result code mapping	23
7	Implementation guidelines	25
8	<b>Problems Related to the signalling-Based Solution</b>	<b>26</b>
9	9.1 <b>Dynamic OTA steering</b>	<b>27</b>
	<b>Steering of Roaming in 5GS</b>	<b>29</b>
	9.2 The Steering of Roaming solution in 5G was developed to fulfil the following aspects that are missing from the currently deployed SOR mechanisms:	
	9.3	29
	Procedures for providing the list of preferred PLMN/access technology combinations	29
	Security mechanisms for Steering of Roaming in 5GS	31
	<b>Annex A Document Management</b>	<b>32</b>
	A.1 Document History	32



## Introduction

### Overview

1 Signalling based methods are being used by operators for steering of their roaming traffic onto preferred networks. As an alternative or in combination with these methods, the operator can also perform steering by updating the content of the preferred PLMN list(s) in the roamer's card (Subscriber Identity Module or Universal Integrated Circuit Card).

These signalling based steering methods are not related to the update of cards but use the SS7 and Diameter signalling procedures, which are addressed to the HPLMN HLR/HSS. This results in roamers being redirected to more preferred network have the drawback of operators receiving error messages indicating network failure.

Besides the commercial implications, there is evidence that these methods cause problems for the VPLMN, which have technical, and QoS implications.

A new method for Steering of Roaming has been defined for 5G and attempts to mitigate many of the issues that are inherent in existing methods for legacy systems.

The goal of this document is:

- To define commercial guidelines which provide a set of minimum requirements for cooperation between networks when SoR is being used.
- To specify the technical implementation requirements, which will result in a minimum impact on the VPLMN network (especially on the SS7 and Diameter links).
- To describe the control plane solution defined for Steering of Roaming in 5G

### 1.2 Scope

The scope includes the implementation of Steering of Roaming using Signalling and OTA methods and the control plane solution for Steering of Roaming in 5GS.

### 1.3

### Definitions

Term	Definition
5GS	5 <sup>th</sup> Generation System
AMF	Access and Mobility Management Function
CP-SOR	Control Plane Steering of Roaming
GT	Global Title
HLR	Home Location Register
HPLMN	Home PLMN
HSS	Home Subscriber Server
IGP	International Gateway Point
IMSI	International Mobile Subscriber Identity
MAP	Mobile Application Part
MSU	Message Signalling Unit

OTA	Over the Air
PLMN	Public Lands Mobile Network
QoS	Quality of Service
SCCP	Signalling Connection Control Part
SIM	Subscriber Identity Module
SOR	Steering Of Roaming using SS7 Methods
SS7	Signalling System N° 7
STP	Signalling Transfer Point
TCAP	Transaction Capabilities Application Part
UDM	Unified Data Management
UDTS	Unit Data Service
UICC	Universal Integrated Circuit Card
VLR	Visitor Location Register
VPLMN	Visited PLMN

### Document Cross-References

1.4

Ref	Document Number	Title
1	3GPP TS 23.401	"GPRS Enhancements for E-UTRAN Access"
2	3GPP TS 23.402	"Architecture enhancements for non-3GPP Accesses"
3	IETF RFC 3588	"Diameter Base Protocol"
4	3GPP TS 29.272	"MME and SGSN related interfaces based on Diameter protocol"
5	GSMA PRD IR.88	"LTE and EPC roaming guidelines"
6	GSMA PRD_IR.33	"GPRS Roaming Guidelines"
7	3GPP TS 23.272	"Circuit Switched Fallback in Evolved Packet System; Stage 2" Release 10
8	3GPP TS 24.301	"Non-Access-Stratum (NAS) protocol for Evolved Packet System (EPS); Stage 3"
9	3GPP TS 29.002	"Mobile Application Part (MAP) specification"
10	3GPP TS 29.010	" Information element mapping between Mobile Station - Base Station System (MS - BSS) and Base Station System - Mobile-services Switching Centre (BSS - MSC); Signalling procedures and the Mobile Application Part (MAP)"
11	3GPP TS 23.122	"Non-Access-Stratum (NAS) functions related to Mobile Station (MS) in idle mode"
12	3GPP TS 23.122	Non-Access-Stratum (NAS) functions related to Mobile Station (MS) in idle mode (Release 15)
13	3GPP TS 24.501	Non-Access-Stratum (NAS) protocol for 5G System (5GS)

14	3GPP TS.29.509	5G System; Authentication Server Services; Stage 3 (Release 15)
15	3GPP TS 31.111	Universal Subscriber Identity Module (USIM). Application Toolkit (USAT) (Release 15)
16	3GPP TS 33.501	Security architecture and procedures for 5G system (Release 15)
17	3GPP TS 23.501	System Architecture for the 5G System, Stage 2 (Release 15)
18	3GPP TS 24.501	Non-Access-Stratum (NAS) protocol for 5G System (5GS); Stage 3 (Release 15)
19	3GPP TS 31.115	Secured packet structure for (Universal) Subscriber Identity Module (U)SIM Toolkit applications (Release 15)
20	3GPP TS 24.008	"Mobile radio interface Layer 3 specification; Core Network protocols"
21	3GPP 03.22	Technical Specification Group GSM/EDGE - Radio Access Network; Functions related to Mobile Station (MS) in idle mode and group receive mode
22	3GPP 04.08	Digital cellular telecommunications system (Phase 2+); Mobile radio interface layer 3 specification

## 2 Steering of Roaming Cooperation Principles

### 2.1 Transparency

SoR via Signalling based methods causes impacts both to the network and the signalling links of the non-benefiting VPLMN. Operators implementing Signalling based SoR are requested to notify their Roaming Partners of the implementation of SoR.

As a minimum, Operators implementing SoR using Signalling based SoR are requested to respond within 2 days to a requesting non-benefiting VPLMN that they have implemented SoR using Signalling methods.

In addition the Operator implementing Signalling based SoR must inform the non-benefiting VPLMN which methods (see sections 6 and 5 of this document) he is using. Depending on the method used, the operator implementing SoR must transmit to the non-benefiting VPLMN, the appropriate technical elements (error codes used, SCCP GT address used or hostname if relevant) in order to allow the non-benefiting VPLMN to limit the impacts on the network supervision.

#### 2.2.1

### Rules for cooperation between networks

#### In case of transparency

Should a severe situation occur with regards to congestion on the non-benefiting VPLMN Network the non-benefiting VPLMN and the Operator implementing Signalling based SoR agree to determine within 3 days the most feasible solution to reduce this problem, according to the following rules:

- The non-benefiting VPLMN has the right to decide to stop troubleshooting and international network supervision for the Operator who has implemented SoR using SS7.
- The non-benefiting VPLMN and the Operator implementing Signalling based SoR agree that the Operator implementing SoR using SS7 stops SoR against that network for a maximum of 3 days to allow the non-benefiting VPLMN time to re-dimension its network.
- As the possibility for the non-benefiting VPLMN to re-dimension its network in time may depend on third parties (carriers), both networks may agree on another scheduling.
- In the case both operators cannot find a short-term solution, the non-benefiting VPLMN may decide to stop further international Roaming provisioning of the network for the Operator who has implemented Signalling based SoR. This stop on further international Roaming provisioning of the network will happen for an undetermined period that will last at a maximum until a solution has been agreed between both parties on the issue. For clarity this stop on further international Roaming provisioning of the network is not a suspension of the international Roaming agreement between both parties. Suspension clauses are already covered by point 14 of document AA.12, and are to be left out of scope of this document.

This stop in the provisioning of international roaming will happen according to the escalation procedures as defined in PRD BA.30.

The method used for the request of cooperation is an e-mail sent from the IREG team of the non-benefiting VPLMN to the Network Operation Centre or 24x7 contact of the Operator implementing Signalling based SoR. From this moment the delay of 3 days given to determine the most feasible solution to reduce this problem between starts.

### 2.2.2 **In case of non transparency**

If the Operator implementing Signalling based SoR does not inform the non-benefiting VPLMN upon its request within a delay of 2 calendar days, the non-benefiting VPLMN has the right to decide:

- To stop troubleshooting and international network supervision for the Operator who has implemented Signalling based SoR
- In the case both operators cannot find a short-term solution, the non-benefiting VPLMN may decide to stop further International Roaming provisioning of the network for the Operator who has implemented Signalling based SoR. This stop on further International Roaming provisioning of the network will happen for an undetermined period that will last at a maximum until a solution has been agreed between both parties on this issue. For clarity this stop on further International Roaming provisioning of the network is not a Suspension of the International Roaming Agreement between both parties. Suspension clauses are already covered by point 14 of document AA12, and are to be left out of the scope of this document.

This stop in the provisioning of international roaming will happen according to the escalation procedures as defined in PRD BA.30.

## Error Codes

The standard error codes to be used for Steering of Roaming are defined in Section 4.4 and 5.4 of this document. If a Customer complaint occurs, operator may bilaterally choose another error code to minimise the customer impact.

2.2.3 All operators using Signalling for SoR must implement any MAP code and Diameter (experimental) result code identified by the GSMA Networks Group (NG).

## SS7 based methods technical description

This section describes the different SS7 based alternative methods used by some operators. 3 It also highlights the impact on the subscriber.

### SS7 Node Based redirection

3.1 These alternative methods can be based on a specific node or new features, which are contained within existing nodes (HLR, STP or IGP) and that intercept the 'Update Location' , 'GPRS Update Location' or 'Send Authentication Message' addressed to the HLR.

Based on the MSC/VLR entity on the SCCP or MAP level, the Redirecting Node will reject or accept to route the message to the HLR. According to TS 24.008, in the case of multiple 'Update rejection', and depending on the used reject causes, the mobile phone will try to select another network.

The HPLMN will be able to force the 'Update location' on a specified network or share the traffic between visited networks.

To redirect the traffic, the node sends different reject causes, which are normally used to report a problem (Update Location, Authentication messages).

Currently, the most commonly used MAP generic user errors for the MAP (GPRS) Update Location operation are as follows:

- Roaming not allowed
- Data missing
- Unexpected Data value
- System failure



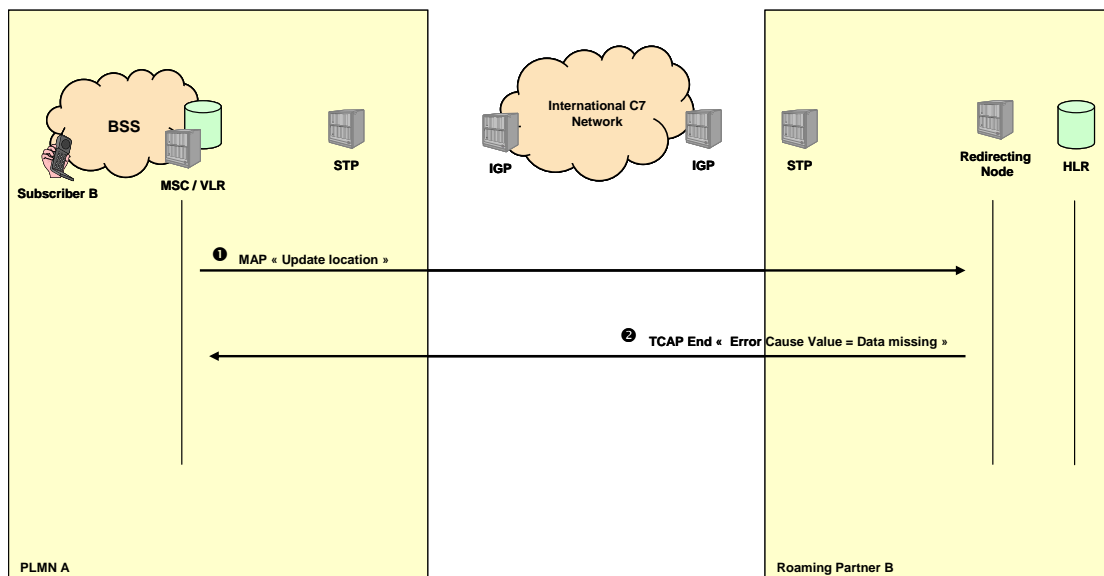
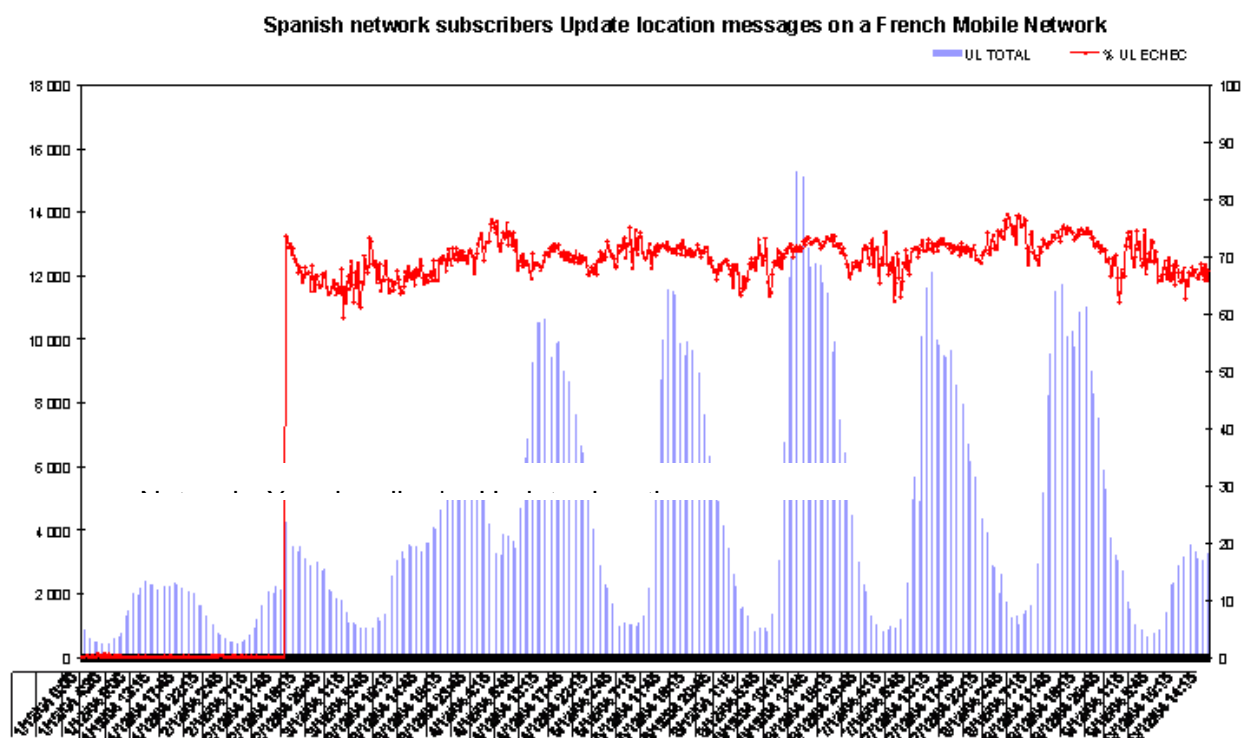

**Figure 1: Network elements involved in MAP signalling**

In a general manner, the manufacturer announced that the increase of the signalling load is between 10 and 20 %. This is when the SOR is correctly implemented and controlled.

As any other service implemented without control, SOR can potentially increase signalling load as shown in the figure below. The example below was observed between two cross border networks. A specific case and can not considered as a general case.

This shows a PLMN mobile operator who uses a multiple MAP reject cause like “unexpected data value”.



**Figure 2: Example for Steering of Roaming (Multiple MAP error cause)**

In this case the average number of 'Update location' messages is 4 times higher. The measurement is made on the number of messages and not on the number of data exchange. This measurement was made during 9 days with a raw data every 15 minutes.

### 3.2

#### **Routing Rules deletion**

Some networks are also using SCCP routing error causes such as:

- UDTs "No translation for this specific address"

This error cause is sent back to the VLR when the SCCP "return on error" flag is set in the request message. It indicates that the HPLMN has simply deleted the route to the VPLMN. If the flag is not set then the VPLMN does not receive any return messages.

When the translation rules are deleted, the 'Update Location' or 'Authentication' procedures will fail during the request to the HLR.

An example, PLMN X mobile operator is using UDTs SCCP error cause value "no translation for this specific address".

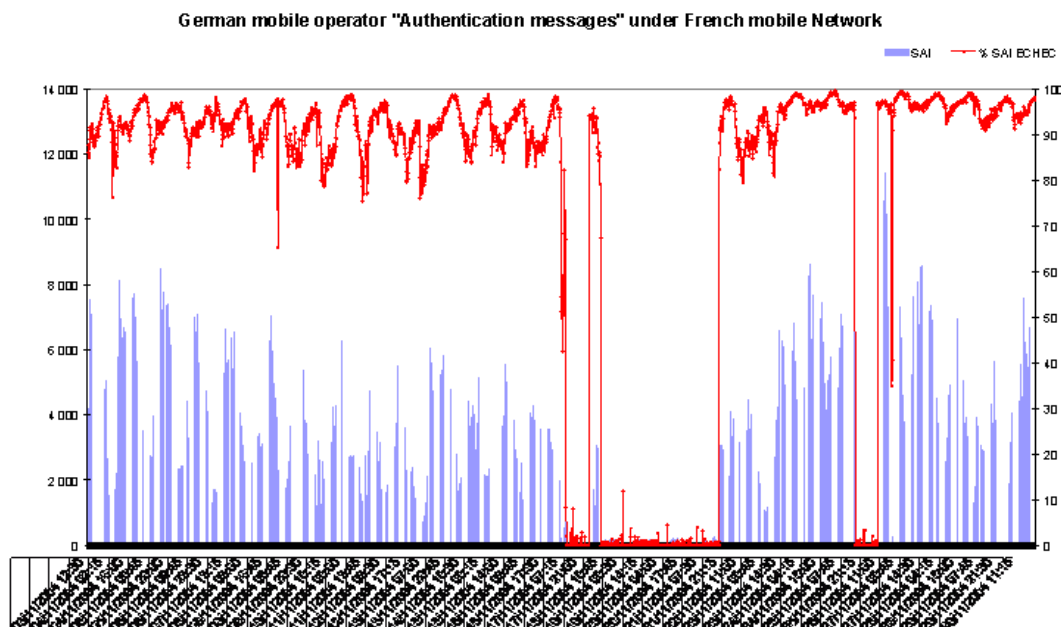

**Figure 3: Example for Steering of Roaming (UDTS Error Cause) – Impact on SAI messages**

To understand how the SS7 network is affected, we can compare the number of Authentication messages exchanged with and without the UDTs redirection system, for a 15 minutes period:

- Average of authentication messages exchange without redirection system: 120,74
- Average of authentication messages exchange with redirection system: 6 882,86

So we have near 57 times more messages than usual in this case. The main reason for this is that the HPLMN and the VPLMN have common cross borders in the given example.

If the all SS7 messages are taken into account, the increase is near 60 %.

	Sent	Received	Total
January-04	21 100	18 000	39 100
February-04	14 346	8 953	23 299
March-04	16 306	10 908	27 214
April-04	29 922	17 922	47 844
May-04	17 889	19 133	37 022
June-04	19 139	17 180	36 319
July-04	15 274	10 879	26 153
August-04	28 388	30 198	58 586
September-04	13 856	11 829	25 685
October-04	19 081	16 746	35 827
November-04	21 088	22 392	43 480
December-04	30 774	32 106	62 880

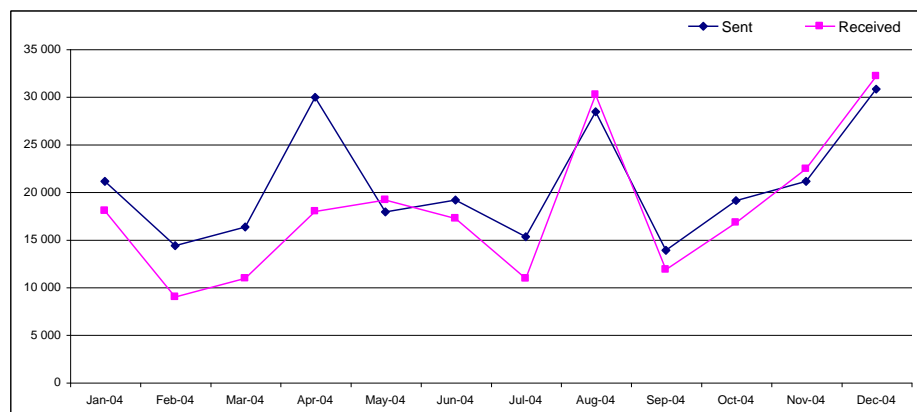

**Figure 4: Example for Steering of Roaming  
(UDTS Error Cause) – Global SS7 impact on MSU**

### 3.3 HLR & VLR Blocking

Other possible methods for the steering of roaming traffic are:

- "HLR blocking"
- "VLR blocking"

In the case of HLR blocking, the HPLMN implements blocking rules in the selected HLR for a roaming partner. As a result the customers from the blocking HLR cannot roam in the selected VPLMN. The number blocked in the HLR determines the percentage of roaming steering being conducted. This results in an increase of "roaming not allowed" messages being sent to the VPLMN and will transfer the PLMN into the SIM forbidden PLMN list.

In case of VLR blocking, the HPLMN implements blocking in all HLRs, for the selected VLR of a roaming partner. As a result, all the customers of the HPLMN cannot roam in the selected regions of the VPLMN. This results in an increase of "roaming not allowed" messages being sent to the VPLMN and will transfer the PLMN into the SIM forbidden PLMN list.

The customers of the HPLMN will not be able to roam onto the VPLMN even in other areas unless they manually select a non-blocked VLR.

Other error causes different from 'roaming not allowed' might be used. A combination of both methods might be used either from HLR or external node.

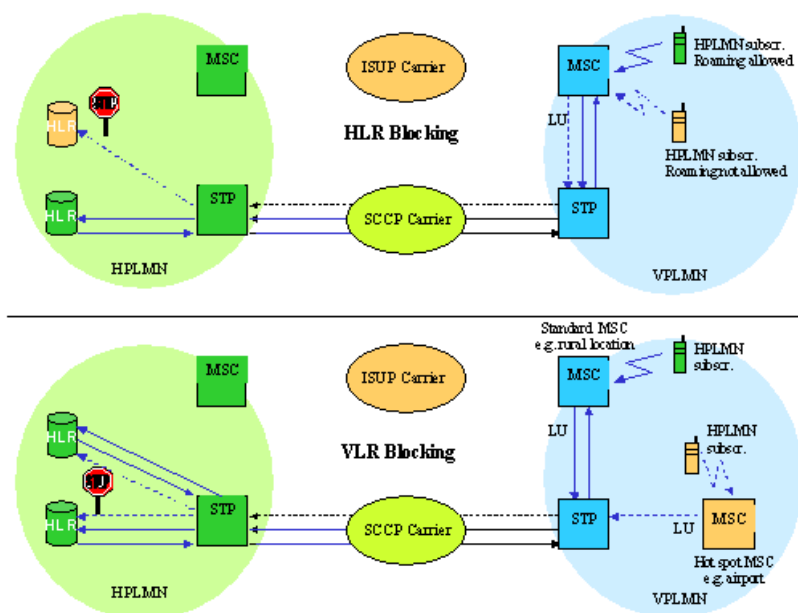

Figure 5: Principle of HLR and VLR blocking mechanisms

## Customer Experience Assessment

4

### SS7 based redirection

4.1

#### Case 1: Handset in the automatic PLMN selection mode

The behaviour of the handset when receiving location update reject is defined in chapter 4.4.4.9 of 3GPP TS 24.008 (chapters 4.7.3.1.4, 4.7.3.2.4 and 4.7.5.1.4 for Attach and Routing Area Update procedure rejected by the network). Whether the mobile is located on a PLMN or not, the handset shall perform 4 location updates (resp 5 attempts for GMM procedures). Chapter 11.2 of 3GPP TS 24.008 states the handset shall wait for 15secs between each attempt. The maximum number of attempts is 4 (resp 5 for GMM procedures). Therefore a 60secs (resp 75s) delay is introduced by the roaming traffic management solution.

Note: if the VPLMN is implementing the Network Operation Mode I and the MS operation mode is A or B then the MS shall register for PS and CS with a GMM combined procedure. If the SoR system only performs steering by acting on the MAP\_Update\_Location procedure then the MS shall follow procedure of 3GPP TS 24.008 chapter 4.7.3.2.3.2 Combined attach successful for GPRS services only and 4.7.5.2.3.2 Combined routing area updating successful for GPRS services only. In such a case, the device will perform 5 combined ATTACH or 5 combined Routing Area Update that will result in 5 MAP\_Update\_Location. A Steering of Roaming procedure upon a combined registration delays the registration by 75s.

3GPP TS 23.122 states that, after a registration failure; if there are more PLMN into the preferred PLMN list, then the handset shall select the next PLMN of the list and try to register on this one.

If the handset finds a suitable cell on this new PLMN, it will register on it. If there is no more PLMN on the list then the handset will select any PLMN available including the PLMN from

which it has been rejected (if generic errors have been used). Then the handset will try to locate on the available PLMN.

We have to note that in the 3GPP 03.22 and 3GPP 04.08, which is relevant to the pre R99 releases, the required behaviour of the mobile is defined differently in the two specifications. The 04.08 sections 4.4.4.7 and 4.4.4.9 show that in most error cases, the mobile should remain camped on the initial PLMN. This misalignment of specifications has caused implementations in mobiles to vary, with some implementing the precise protocol definition of 04.08, and some implementing a “best” interpretation of the service overview in 03.22. If the mobile remains camped on the initial PLMN then the user does not receive service unless he initiates manual selection on another PLMN.

We should also note that the “4 attempts counter” and associated timers described in the 4.4.4.9 section can get readily reset by the mobile doing cell reselection leading to an increase of messaging between the mobile and by the MSC. This will happen often in the PLMN and cell border conditions.

### **Case 2: handset in manual PLMN selection mode**

When in manual mode, the behaviour of handset during update location procedure is exactly the same as for automatic mode. There will be 4 attempts (resp 5 for GMM procedures) with a 15s delay between each. At the end of the 4<sup>th</sup> location update rejection, the handset will display the available PLMN once again to the customer asking him to select one. The customer can still try to select the same one.

In summary, the customer will experience a 60s delay per PLMN when being redirected. When in automatic or manual mode, the same PLMN could be selected again for registration (if it is the only available PLMN or if selected by the customer once again).

It is likely that SS7 based solution is implemented using an external node and allows the HPLMN operator to control the location update.

Such equipment can:

- Assess manual mode based on attempt numbers and allow the customer to finally register on the selected PLMN if selected twice. There fore, there is no roaming restriction.
- Assess lack of coverage from other PLMN and allow the customer to register on rejected PLMN if selected again.
- Monitor the delay between each location procedure and avoid redirecting too much a customer that is in a bad coverage area, which could lead to a “ping pong” between PLMNs and SS7 traffic increase.

5

## **SS7 steering implementation Guidelines**

This section gives the GSMA recommendation for the Steering of Roaming based on SS7 methods implementation. Technical Restrictions to SoR implementation included in this document must not be used by visited PLMN to counteract the redirection mechanism. The VPLMN shall also not interfere in any mean with a Location Update procedure initiated on a competitor network to retain inbound roamers on its network.

- The VPLMN shall forward the MAP Update Location response messages received from the HPLMN transparently to the Mobile Station.
- It shall also not send at any moment any faked MAP Update Location request message to the HPLMN. By faked we mean any message which does not result of a Location Updating procedure initiated by the handset.

### Protocol Level

5.1 The optimal SS7 based solution must be implemented on the MAP level, because this is the application level protocol. The SCCP level is expected to be used for routing and SOR must not be implemented on this level.

### Procedure

5.2 The only MAP operations recommended for use with SOR are 'Update Location' and 'Update GPRS Location'. The HPLMN must implement SOR on these MAP procedures and shall only send one response for each 'Update Location' or 'Update GPRS Location' operation.

For clarity in the interpretation of the preceding sentence, a MAP-InsertSubscriberData-Operation (TC-Invoke) shall not be counted as a response to the MAP-UpdateLocation-Operation (TC-Invoke) or a MAP-Update-GPRS-Location (TC-Invoke).

The HPLMN should do its best to send TC-components in the order as defined in 29.002 v 3.20.0 Section 19.1 (Location Management). Therefore the HPLMN should not transmit, with the same transaction identities, a MAP-InsertSubscriberData Operation (TC-Invoke in TC-Continue) after sending the MAP-UpdateLocation response (TC-result/Error/Reject/Abort in TC-End/TC-Abort).

Other operations should be handled transparently. For instance 'Send Authentication Information/ Send Parameters' should not be used for Steering of Roaming purposes.

The treatment of MAP 'Update GPRS Location' is similar to the MAP 'Update Location'. The SoR system shall steer in a consistent manner both MAP operations (reject or allow both) to avoid partial service disruption due to successful registration only in a single domain. For instance, if the SoR system is performing a steering procedure by rejecting a MAP-Update-Location and receives a MAP-Update-GPRS-Location, it shall also reject this procedure.

5.3 If the VPLMN has implemented Network Operation Mode I, the SoR system that would only perform redirection based on MAP-Update\_Location and not based on MAP\_Update\_GPRS\_Location would receive 5 MAP\_Update\_Location\_Request as the device will perform 5 Combined Attach or Routing Area Procedures and should identify it as a Manual Mode selection performed by the roamer (see 5.5).

### Map error cause mapping between network and terminal device

The error cause mapping between the Mobile station and the network is defined in the 3GPP TS 29.010 specification. The network should be compliant with this specification and relay it transparently to the Mobile station.

Below are two tables extracted from Section 3.2 for GMM and 3.8 for MM of 3GPP TS 29.010 (Only the error codes highlighted in yellow are applicable to the Steering of Roaming):

<b>MM Error code</b>	<b>24.008</b>	<b>29.002</b>	<b>MAP Error code</b>
	<b>MM (Location Updating Reject)</b>	<b>MAP_Update Location response</b>	
# 2	IMSI unknown in HLR	Unknown subscriber	# 1
# 11	PLMN not allowed	Roaming not allowed: PLMN not allowed	# 8
# 12	LA not allowed	-	
# 13	Roaming not allowed in this LA	-	
# 15	No suitable cells in location area	-	
# 11	PLMN not allowed	Roaming not allowed: Operator determined barring	#8
# 3	Illegal MS	-	
# 6	Illegal ME	-	
# 17	Network failure	System Failure	# 34
# 17	Network failure	Data Missing	# 35
# 17	Network failure	Unexpected data value	# 36
# 17	Network failure	MAP U/P ABORT	
# 17	Network failure	MAP_NOTICE	
# 17	Network failure	MAP_CLOSE	

**: MAP to Mobility Management error mapping**

<b>GMM Error code</b>	<b>24.008</b>	<b>29.002</b>	<b>MAP Error code</b>
	<b>GMM (Routing Area Update Reject)</b>	<b>MAP_Update GPRS Location response</b>	
# 7	GPRS services not allowed	Unknown subscriber (no GPRS subscription)	# 1
# 8	GPRS services not allowed	Unknown subscriber (IMSI unknown)	# 1
# 14	GPRS services not allowed in this PLMN	Roaming not allowed: PLMN not allowed	# 8
# 12	LA not allowed	-	
# 13	Roaming not allowed in this LA	-	
# 15	No suitable cells in location area	-	
# 14	GPRS services not allowed in this PLMN	Roaming not allowed: Operator determined barring	#8
# 3	Illegal MS	-	



<b>GMM Error code</b>	<b>24.008</b>	<b>29.002</b>	<b>MAP Error code</b>
# 6	Illegal ME	-	
# 17	Network failure	System Failure	# 34
# 17	Network failure	Unexpected data value	# 36
# 17	Network failure	MAP U/P ABORT	
# 17	Network failure	MAP_NOTICE	
# 17	Network failure	MAP_CLOSE	

#### : MAP to GPRS Mobility Management error mapping

Note: The VPLMN should not perform a different mapping of MAP error cause to MM/GMM error causes. For instance, Error Code #111 Protocol error, unspecified, is not documented in 3GPP TS29.010 and the VPLMN shall not map a MAP error cause into #111.

### Implementation of Error codes

- 5.4. The steering of Roaming shall be performed by rejecting the MAP procedure.

The recommended result codes for MAP "Update Location" and MM NAS error codes are:

<b>MAP-UL error code for SoR</b>	<b>UE behaviour (MM NAS)</b>
Roaming not allowed (#8)	Upon reception of MM cause #11 "PLMN not allowed", the UE shall store the PLMN identity in the "forbidden PLMN list" and perform a PLMN selection according to [12]
System Failure (#34) Data Missing (#35) Unexpected data value (#36)	Upon reception of MM cause #17 "Network failure", the terminal will attempt to repeat the LU 3 more times. Subsequently depending on the mobile's implementation, the terminal may select another PLMN or remain on the same network.

#### : Recommended MAP UL result codes for SS7 Steering of Roaming

The recommended result codes for MAP "Update GPRS Location" and GMM NAS error codes are:

<b>MAP UL-GPRS error code for SoR</b>	<b>UE behaviour (GMM NAS)</b>
Roaming not allowed (#8)	Upon reception of GMM cause #14 "GPRS services not allowed in this PLMN", the UE shall store the PLMN identity in the "forbidden PLMN list for GPRS" and may perform a PLMN selection according to [12]
System Failure (#34) Unexpected data value (#36)	Upon reception of GMM cause #17 "Network failure", the terminal will attempt the LU 4 more times. Subsequently depending on the mobile's implementation, the terminal may select another PLMN or remain on the same network.

**: Recommended MAP UL-GPRS result codes for SS7 Steering of Roaming**

Note: Roaming not allowed: The impact is that the VPLMN would be put into the forbidden list (The forbidden list maybe updated via OTA, and is likely to be over-written when returning to the home country). The registration on that VPLMN will be allowed only by a manual selection. The behaviour of the handset to this rejection cause depends on the handset model and manufacturer.

Note: Unexpected data value: The use of this error codes increase the signalling traffic between the home and the visited PLMN.

The solution with the less signalling impact for the non-benefiting VPLMN is 'Roaming Not Allowed', however some operators may prefer to use 'Unexpected Data Value' to allow automatic handset attempts in case of no coverage of preferred VPLMN.

**Management**

5.5 In order to meet customer service expectations and control the volume of signalling, a range of mechanisms are recommended to be supported.

(A) Whatever error code is chosen, the home network must allow the customer to perform a successful manual network selection on second attempt and on the VPLMN that the customer was just rejected from.

- Roaming Not Allowed: This is the chosen optimal mechanism. As the forbidden list will be updated with this mechanism it is up to the HPLMN to determine the user experience of manual selection. One proposal is to allow manual selection (if there is a second attempt on the rejected VPLMN, it is allowed).

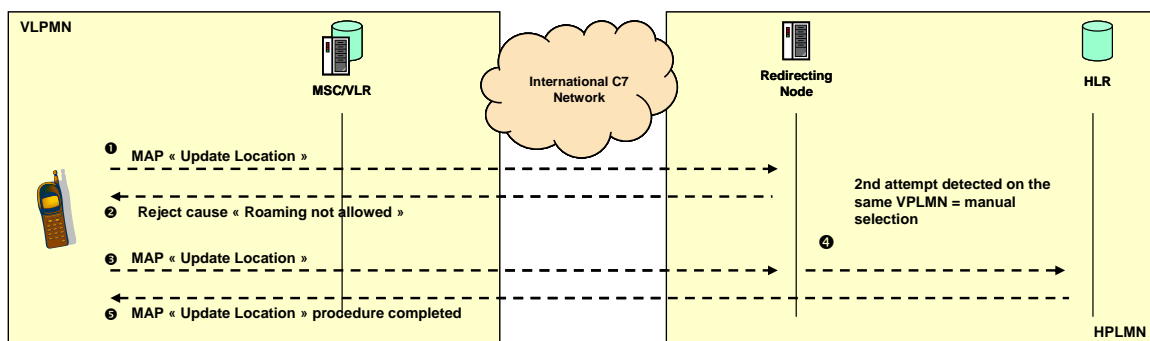

**Figure 6: Mechanism of the “Roaming Not Allowed” Error Code**

- Unexpected Data value: The home network must not reject more than 4 attempts; the 5<sup>th</sup> attempt on the rejected VLR must be accepted. This is covering manual selection or the case where the rejected VPLMN is the only coverage available.

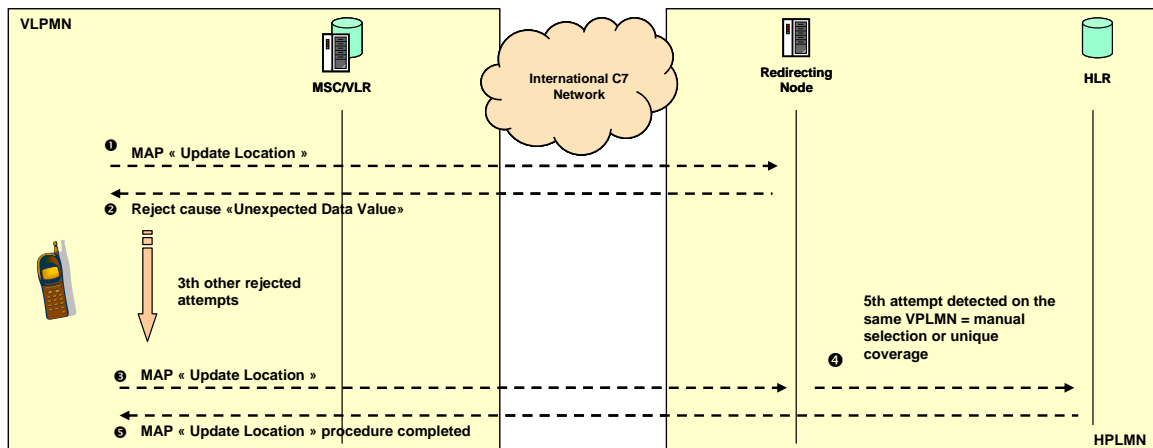

**Figure 7: Mechanism of the “Unexpected Data Value” Error Code**

(B) To limit the number of rejections per customer, a maximum number of rejected attempts can be specified for a VPLMN and for a given period. For example, 5 rejected attempts per 24 hours and per customer.

### 5.6 Specific SCCP Global Title

The HPLMN will choose a specific SCCP GT. The specific SCCP GT will be used only in the case where ‘Unexpected Data Value’ is used.

In order to differentiate between a real problem and Steering of Roaming reject messages, a specific SCCP GT should be dedicated. The VPLMN, by correlation between the calling SCCP GT and the error codes, will be able to distinguish between:

- Real problem and Steering of Roaming
- An increase of SS7 messages from what is normally expected
- This SCCP GT must be communicated to the VPLMN if requested and on any GT changes.

6 The VPLMN shall not discard the messages sent by this SCCP GT.

### 6.1 Diameter steering (steering in LTE networks)

#### Technical description

Before describing the LTE steering method, it is important to explain how the registration process occurs in a LTE network. In the Evolved Packet Core, the Diameter protocol has replaced the MAP.

The Attach procedure (or Tracking Area Update with MME change) triggers the Diameter Update Location procedure between the MME and the HSS., They exchange Diameter Update Location Request (ULR) and Update Location Answer (ULA) messages. This is illustrated below. The radio procedure has been simplified.

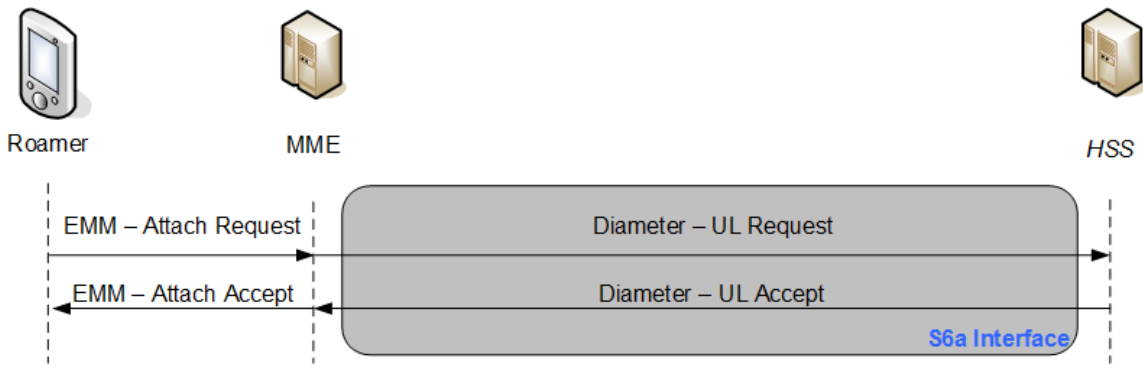

**Figure 8: simplified Attach procedure**

The Steering of Roaming system performs redirection of a LTE device in a similar manner than with SS7 messages. The SoR system will reject the Update Location procedure by sending a ULR with an appropriate result code back to the MME. This is illustrated below:

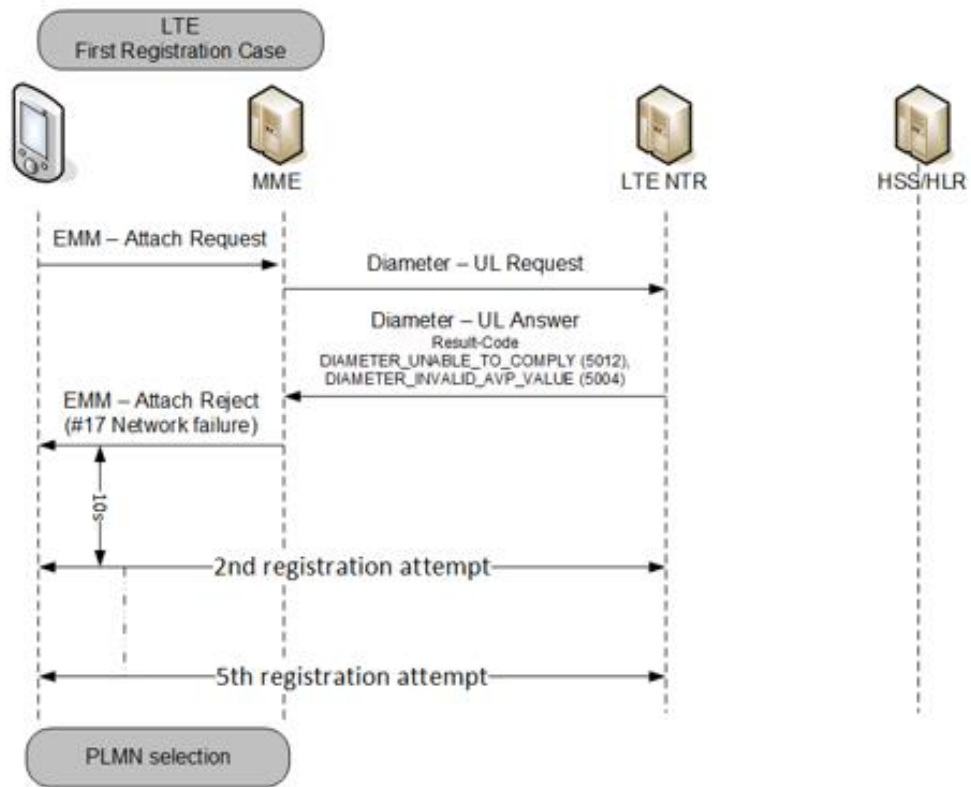

**Figure 9: Diameter SoR with DIAMETER\_UNABLE\_TO\_COMPLY or DIAMETER\_INVALID\_AVP**

Another illustration with a different Diameter result code.

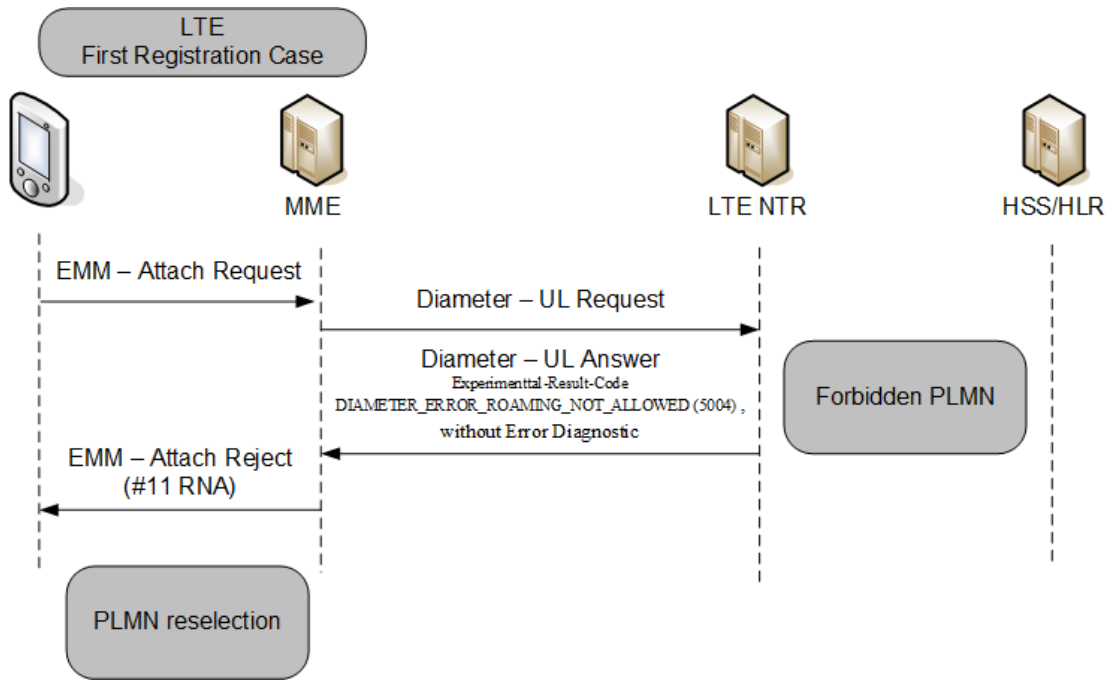
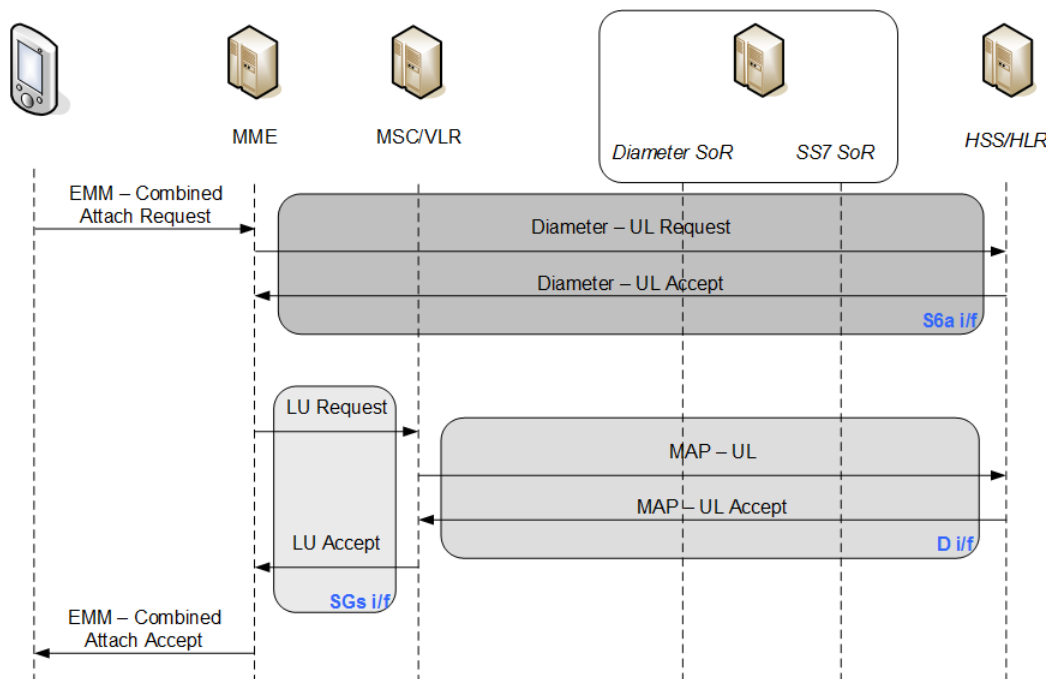

**Figure 10: Diameter SoR with DIAMETER\_ERROR\_ROAMING\_NOT\_ALLOWED w/o Error Diagnostic**

The steering in LTE networks relies on the same technical principal as SS7 steering. This can be seen as an evolution of the SS7 node based steering solutions.

### CSFB issues

CSFB introduces a greater complexity in steering. The registration in EPS of CSFB devices is illustrated below. The radio procedure has been simplified. There is one Diameter Update Location procedure and another MAP one for CS services.

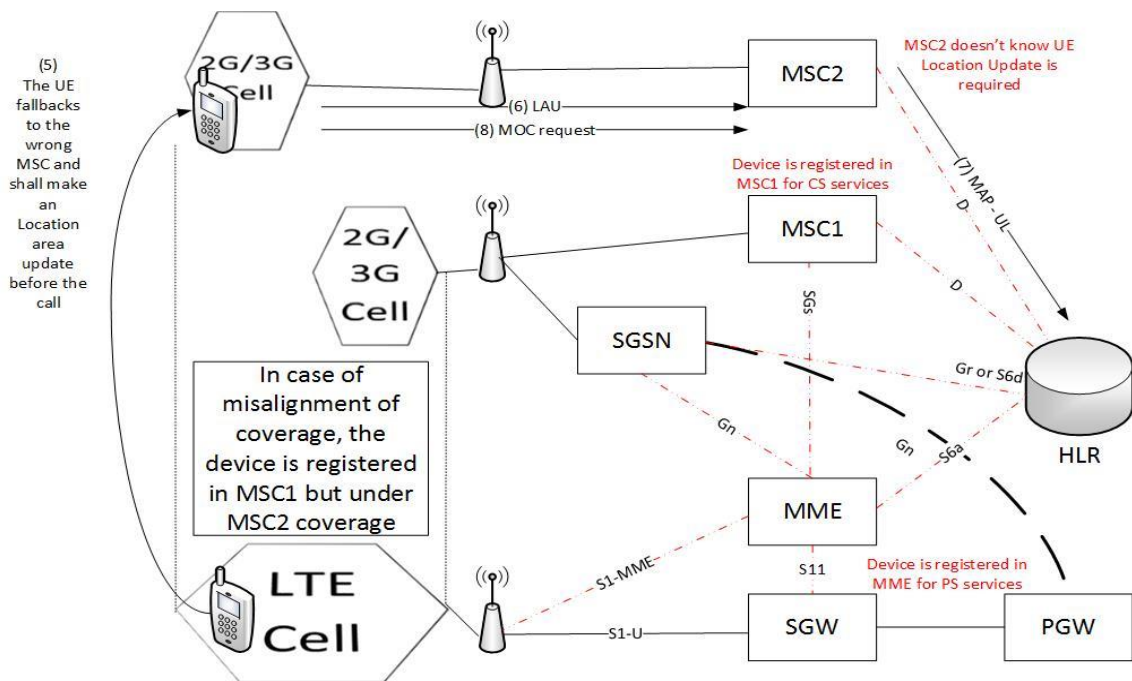

**Figure 11: Simplified Combined EPS registration for CSFB**

The combined registration in EPS for PS and CS services has to be steered consistently in order to avoid partial service disruption or steering failure that might occur if only the Diameter procedure is allowed but not the MAP one.

It is important to note that if the Diameter procedure is successful but the MAP one isn't due to inconsistent steering, the device will perform 1 Attach attempt followed by 5 Tracking Area Update attempts. Each of them will trigger a MAP Update Location procedure in the VLR. At the 5<sup>th</sup> attempt (4<sup>th</sup> TAU), the SS7 SoR system shall detect manual mode according to chapter 5.5 and shall stop steering leading to steering failure. If for any reason the SS7 SoR system rejects the MAP procedure 2 more times then the CSFB device will select another RAT in the same PLMN and will disable the E-UTRA capability (see [8] chapter 5.5.1.3.4.3 Combined attach successful for EPS services only) leading to LTE service disruption.

Additionally the MAP Update Location or Update GPRS Location might be observed in case of MO or MT activity when the initial MSC associated by MME is not the one actually controlling the cell that will deliver CS service. This occurs in case of TALA misalignment and is illustrated below.



**Figure 12: TALA misalignment issue**

If the SoR system attempt a redirection upon the MAP Update Location procedure of the CSFB MOC or MTC then the call will fail.

TALA misalignment is a known issue that can be mitigated by various solutions (see [5]) but it occurs if:

1. The VPLMN has implemented CSFB where only one or two dedicated MSC support the SGs interface. In such a case, the device will always perform a Location Area Update before the CSFB call. There is a relatively high risk to attempt steering upon reception of a MAP\_Update\_Location message during a CSFB call.
2. The VPLMN has implemented more than one MSC pools (one per region for instance). The device may perform a Location Area Update before the call at MSC pool borders and if there is a TA/LA misalignment at the border. In such as case, there is a little risk to attempt steering upon reception of a MAP\_Update\_Location message during a CSFB call.

6.3

**Result code mapping**

Mapping between Diameter result codes and experimental result codes to NAS Cause Code values is given in Annex A of [4] and is copied below.

Reject indication received at MME over S6a	NAS Cause Code sent to UE
Experimental-Result-Code DIAMETER_ERROR_USER_UNKNOWN (5001)	#8 "EPS services and non-EPS services not allowed"
Experimental-Result-Code	#15 "No suitable cells in tracking area"

DIAMETER_ERROR_UNKNOWN_EPS_SUBSCRIPTION (5420) without Error Diagnostic, or with Error Diagnostic of GPRS_DATA_SUBSCRIBED	
Experimental-Result-Code DIAMETER_ERROR_UNKNOWN_EPS_SUBSCRIPTION (5420) with Error Diagnostic of NO_GPRS_DATA_SUBSCRIBED	#7 "EPS services not allowed"
Experimental-Result-Code DIAMETER_ERROR_RAT_NOT_ALLOWED (5421)	#15 "No suitable cells in tracking area", or #13 "Roaming not allowed in this tracking area", or #12 "Tracking area not allowed" (NOTE 1)
Experimental-Result-Code DIAMETER_ERROR_ROAMING_NOT_ALLOWED (5004) , without Error Diagnostic	#11 "PLMN not allowed"
Experimental-Result-Code DIAMETER_ERROR_ROAMING_NOT_ALLOWED (5004), with Error Diagnostic of ODB_HPLMN_APN or ODB_VPLMN_APN	#14 "EPS services not allowed in this PLMN"
Experimental-Result-Code DIAMETER_ERROR_ROAMING_NOT_ALLOWED (5004), with Error Diagnostic of ODB_ALL_APN	#19 "ESM failure"
Result-Code DIAMETER_AUTHORIZATION_REJECTED (5003) DIAMETER_UNABLE_TO_DELIVER (3002) DIAMETER_REALM_NOT_SERVED (3003)	#15 "No suitable cells in tracking area"
Result-Code DIAMETER_UNABLE_TO_COMPLY (5012), DIAMETER_INVALID_AVP_VALUE (5004) DIAMETER_AVP_UNSUPPORTED (5001) DIAMETER_MISSING_AVP (5005) DIAMETER_RESOURCES_EXCEEDED (5006) DIAMETER_AVP_OCCURS_TOO_MANY_TIMES (5009) Experimental-Result-Code DIAMETER_AUTHENTICATION_DATA_UNAVAILABLE (4181) (NOTE 2)	#17 "Network failure" or #42 "Severe network failure" (NOTE 1)
NOTE 1: Any of those NAS Cause Code values may be sent to the UE, depending on operator's choice. NOTE 2: Any other permanent errors from the diameter base protocol, not listed here, should be mapped to NAS Cause Code #17 "Network failure".	



## : Mapping from Diameter result code to NAS Cause Code values

### Implementation guidelines

The steering of Roaming shall be performed by rejecting the Diameter procedure.

6.4 The recommended result codes are:

Result code for SoR	UE behaviour
DIAMETER_ERROR_ROAMING_NOT_ALLOWED (5004) , without Error Diagnostic	Upon reception of EMM cause #11 "PLMN not allowed", the UE shall store the PLMN identity in the "forbidden PLMN list" and perform a PLMN selection according to [11]
DIAMETER_ERROR_ROAMING_NOT_ALLOWED (5004), with Error Diagnostic of ODB_ALL_APN From Release 10	Upon reception of the EMM cause #19 "ESM failure", the UE may set the attach attempt counter to 5 and perform a PLMN selection according to [11].
DIAMETER_UNABLE_TO_COMPLY (5012)	<p>Upon reception of the EMM cause #17 "Network failure" the UE increments the attach attempt counter. When it reaches 5 the UE perform a PLMN selection according to [11].</p> <p>Upon reception of the EMM cause #42 "Severe network failure" (from Release 11) the UE shall set the attach attempt counter to 5. The UE shall start an implementation specific timer, setting its value to 2 times the value of T as defined in [11]. While this timer is running, the UE shall not consider the PLMN + RAT combination that provided this reject cause as a candidate for PLMN selection. The UE then performs a PLMN selection according to [11].</p>

### : Recommended Diameter result codes for LTE Steering of Roaming

The solution with least signalling impact for the non-benefiting VPLMN is DIAMETER\_ERROR\_ROAMING\_NOT\_ALLOWED (5004) , without Error Diagnostic, however some operators may prefer to use another one as the UE is prevented to register onto the barred PLMN until a successful manual registration occurs or the PLMN is deleted from the Forbidden PLMN list in the SIM. It may prevent the roamer to access his services if the PLMN is the only one covering the location.

The solution with least impact on the roamer is DIAMETER\_ERROR\_ROAMING\_NOT\_ALLOWED (5004), with Error Diagnostic of ODB\_ALL\_APN as there may be no retry if the UE sets the attempt counter to 5 upon reception and there is no PLMN restriction. But it is only available from R.10 and the counter setting to 5 is subject to manufacturer implementation.

Whatever error code is chosen, the home network must allow the customer to perform a successful manual network selection on second attempt and on the VPLMN that the customer was just rejected from.

The HPLMN will choose a specific Diameter Hostname for the SoR system to allow the VPLMN identifying real problem from SoR procedures. The VPLMN shall not discard the messages sent from this hostname as it is anti steering practices and are forbidden by the GSMA.

To avoid CSFB service impact and UE disabling the E-UTRA capability, the Diameter and SS7 SoR systems must steer consistently. The SoR system shall be able to recognize MAP Update Location procedures due to mobility procedure from those due to CSFB calls in case of TA/LA misalignment and shall not steer the second ones to avoid call failure.

## **Problems Related to the signalling-Based Solution**

- 7 This section describes the major problems caused by the signalling -based solution (SS7, Diameter). Regarding the technical aspects, the following issues need to be addressed:

### **Supervision problems**

Alarms are generated for VPLMN Roamers in the case of Location Update or authentication. Alarm monitoring systems are disturbed due to the number of alarms, which normally occur in real network failures. It will also be hard to distinguish between real network failure and Steering of Roaming traffic. A solution needs to be identified in the case of Steering of Roaming traffic.

### **Trouble Shooting Problems**

Dedicated Roaming teams are trying to identify the origin of the problem. Usually, the HPLMN will not send a reply to report a fault as this results in unnecessary costs of time and effort.

### **QoS Definition Problem**

Current QoS monitoring will be disturbed because some network error causes are used for SoR.

The current defined QoS values will be exceeded and automatically defined procedures will alert of false messages.

Redefinition of QoS shall take place. Further sections will help on redefinition.

### **SS7 Network Overload and Denial of Service**

By using this type of error cause, the HPLMN will increase the number of signalling generated by the VPLMN. In the case of a general use of this specific system, the signalling network will be overloaded.

## G3GPP Standards

ven if the error message is fully compliant with the 3GPP standards, the error cause used does not correspond to the initial purpose of the reject. That is why it is required, the redefinition or the enhancing of the the current update location procedure (Please refer to the next section of this document).

### Dynamic OTA steering

OTA steering was introduced before SS7 steering but suffer from several issues solved by 8 SoR systems.

- Non real time – the preferred PLMN list in the SIM may be updated but the device will not take it into account unless a REFRESH command is received or the device is turned off and on
- Lack of accuracy – the list sent OTA to update the preferred PLMN list is always the same and steer the traffic to the first preferred without any feedback in case traffic commitments are exceeded
- Lack of flexibility – changing preferred partner and updating all SIMs was long

REFRESH for SOR was introduced by 3GPP to cope with GSMA requirement. With support of REFRESH, the OTA steering becomes real time and predictable as the device immediately perform a PLMN selection and will select the new preferred PLMN sent over the air.

The figure below illustrates how dynamic OTA steering can be achieved by an end to end solution including:

- The SoR system that computes the preferred PLMN updated list content in real time and sends a REFRESH for SOR request to the OTA platform with the updated PLMN list
- The OTA platform that manages the communication with the REFRESH application and relays the REFRESH for SOR request with the updated PLMN list
- The REFRESH application that relays the REFRESH for SOR request with the updated PLMN list to the device
- The device that performs a PLMN selection upon REFRESH reception with the updated list

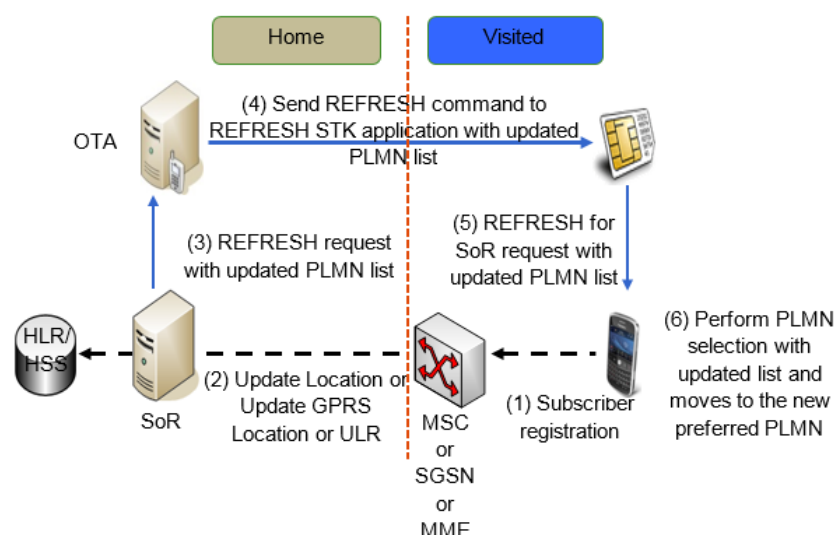

**Figure 13: Dynamic OTA steering end to end description**

If the device does not support the Steering of Roaming refresh type it is still possible to perform dynamic OTA steering with the below procedure.

- The SoR system that computes the preferred PLMN updated list content in real time and request OTA update to the OTA platform
- The OTA platform that performs the OTA update of the preferred PLMN list with the card
- The SoR system that sends a REFRESH request to the OTA platform (with type NAA initialization and full file change notification for instance)
- The OTA platform that manages the communication with the REFRESH application and relays the REFRESH request
- The REFRESH application that relays the REFRESH for SOR request with the updated PLMN list to the device
- The device that reads again the preferred PLMN list and performs a PLMN selection as part of NAA initialization upon REFRESH reception

## Steering of Roaming in 5GS

**The Steering of Roaming solution in 5G was developed to fulfil the following aspects that are missing from the currently deployed SOR mechanisms:**

9

- 9.1
- to provide a standardised steering of roaming mechanism when the UE is trying to register with the VPLMN. Specifically, the requirement was to allow the HPMN to request a UE, that is in automatic mode, to find and register on a different VPLMN from the one it is currently using or trying to register on, provided another VPLMN, that is not in a Forbidden List, is available.
  - to enable the UE to detect whether the selected VPLMN correctly transmits the control plane SoR information provided by HPLMN and if the UE finds that the selected VPLMN does not transmit or modifies the control plane SoR information provided by HPLMN, to enable the UE to stop using such a misbehaved VPLMN, whenever possible.

The 5GS introduces a control plane SOR solution that allows the HPMN to direct the UE during or after registration on the VPMN. Details on the interfaces and how registration process occurs in a 5GS can be found in 3GPP TS.23.501 (Rel. 15) [17] and 3GPP TS 24.501 (Rel.15) [18] respectively. In the 5G Core, the HTTP/2 protocol has replaced the Diameter (LTE). This 5GS SoR solution does not preclude the use of the existing mechanisms for SoR as defined earlier in this document.

The CP-SOR in 5G can be utilized either during registration or after registration by allowing the HPMN to securely update the "Operator Controlled PLMN Selector with Access Technology" list in the UE by providing the HPLMN protected list of preferred PLMN/access technology combinations via NAS signalling. The HPLMN updates the "Operator Controlled PLMN Selector with Access Technology" using this mechanism based on the operator policies (e.g. VPMN preference, UE location).

The use of CP-SOR mechanisms are optional for the HPMN while the support of the feature is mandatory in all 5GS UEs and by the VPMN functions (AMF). If the HPMN chooses to utilize this mechanism, the HPMN must configure their UE's USIM to support the reception of the steering of roaming information at the initial registration in a VPMN. As well, the HPLMN will need to indicate that the UE is expected to receive the steering of roaming information, during the initial registration in a VPMN, in the subscription information in the UDM. If this is done, then it is mandatory for the HPLMN to provide the steering of roaming information to the UE during initial registration. In addition, the HPLMN can request the UE to provide an acknowledgement of successful reception of the steering of roaming information.

9.2

### **Procedures for providing the list of preferred PLMN/access technology combinations**

As noted above, the CP-SOR solution, once configured, can be utilized during the UE initial registration on the VPMN or after its registration. The figures below, from 3GPP TS 22.122,

Annex C (Rel. 15) [12] show the flows during both initial registration (Figure X) and after registration (Figure Y).

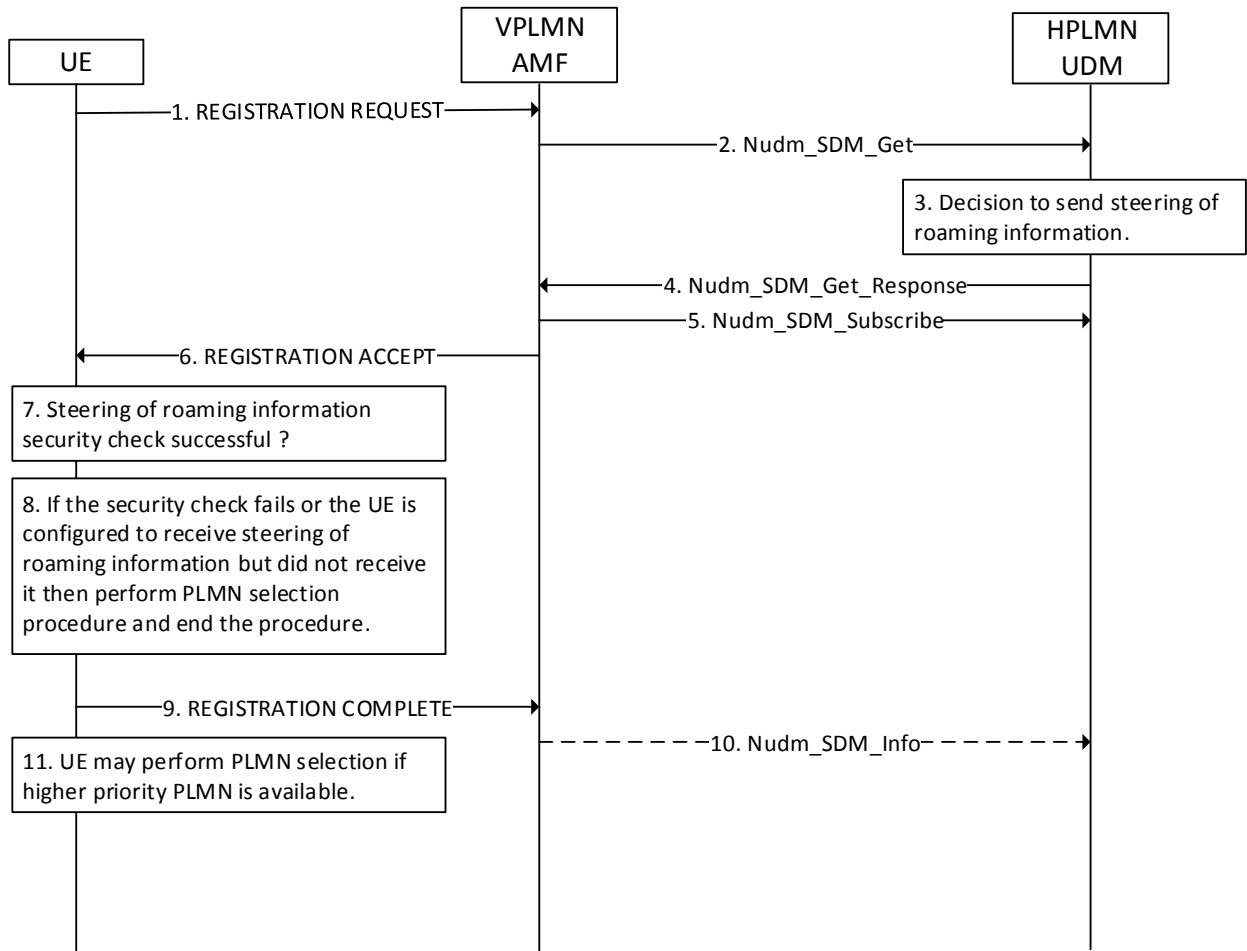

**Figure 14: Flow for the steering of UE in VPLMN during registration**

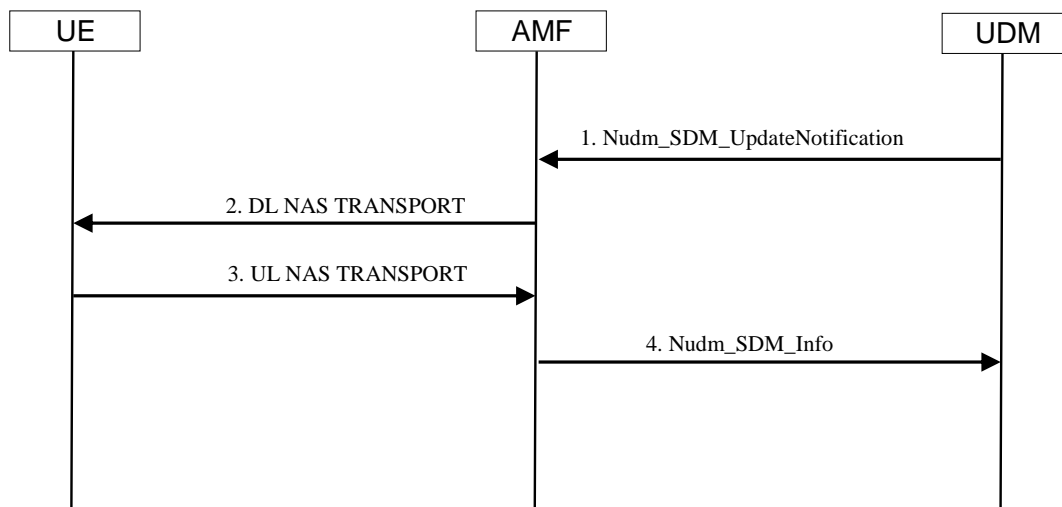

**Figure 15: Flow for the steering of UE in VPLMN after registration**

### 9.3 Security mechanisms for Steering of Roaming in 5GS

The necessary security functions to support the CP-SOR in the 5GS are defined in 3GPP TS 33.501, section 6.14 (Rel 15) [16]. Mechanisms to ensure message security and integrity have been developed and can be found in 3GPP TS 31.115 Rel 15 [19].

## Annex A Document Management

### A.1 Document History

Version	Date	Brief Description of Change	Approval Authority	Editor / Company
0.1	13 May 2005	Produced for comments		Matthieu FOUQUET Bouygues Telecom (France)
0.2	19 May 2005	Minor correction		GSMA director
0.3	20 May 2005	Error code value added in Section 2 MAP Error Table.		
0.4	24 May 2005	Comments from SOR #3 meeting		
0.5	30 May 2005	Input related to the SOR #3 actions and comments		GSMA
0.6	31 May 2005	Input regarding the communication method used for the VPLMN request to the HPLMN implementing SOR.		
0.7	09 June 2005	Comments after the conference call and e-mail discussion (06 June 2005)		
0.8	14 June 2005	Comments after discussion via e-mails.		
0.9	27 June 2005	Modification of the graphs titles.		
1.0	27 June 2005	Convert to version 1.0		
2.0	24 January 2006	New version after the Major Change request 001 and Minor Change request 001		Telefonica Moviles (Spain)
2.1	13 March 2006	Minor Change request 002		Telefonica Moviles (Spain)
2.2	08 August 2006	Minor Change request 003		Orange (France)
3.0	08 August 2006	To incorporate status change to 'binding' (PMO)		
4.0	08 October 2014	Change Request CR1001 included	IREG/PSMC	Laurent Dubesset (Mobileum Inc)



<b>Version</b>	<b>Date</b>	<b>Brief Description of Change</b>	<b>Approval Authority</b>	<b>Editor / Company</b>
5.0	4 May 2020	IR.73 CR1002 Authorized error code IR.73 CR1003 Add 5G Control Plane SOR	NG	Javier Sendin/GSMA

**Other Information**

Type	Description
Document Owner	IREG / Signal
Editor / Company	Laurent Dequidt / Bouygues Telecom, France

It is our intention to provide a quality product for your use. If you find any errors or omissions, please contact us with your comments. You may notify us at [prd@gsma.com](mailto:prd@gsma.com)

Your comments or suggestions & questions are always welcome.